

ADM3491

FEATURES

- Operates with +3.3 V Supply
- EIA RS-422 and RS-485 Compliant Over Full CM Range
- 19 k Ω Input Impedance
- Up to 50 Transceivers on Bus
- 20 Mbps Data Rate
- Short Circuit Protection
- Specified Over Full Temperature Range
- Thermal Shutdown
- Interoperable with 5 V Logic
- 840 μ A Supply Current
- 2 nA Shutdown Current
- Also Available in TSSOP Package
- Meets IEC1000-4-4 (>1 kV)
- 8 ns Skew
- Upgrade for MAX 3491, SN75ALS180

APPLICATIONS

- Telecommunications
- DTE-DCE Interface
- Packet Switching
- Local Area Networks
- Data Concentration
- Data Multiplexers
- Integrated Services Digital Network (ISDN)
- AppleTalk
- Industrial Controls

GENERAL DESCRIPTION

The ADM3491 is a low power differential line transceiver designed to operate using a single +3.3 V power supply. Low power consumption coupled with a shutdown mode make it ideal for power sensitive applications. It is suitable for communication on multipoint bus transmission lines.

It is intended for balanced data transmission and complies with both EIA Standards RS-485 and RS-422. It contains a differential line driver and a differential line receiver, making it suitable for full duplex data transfer.

The input impedance is 19 k Ω allowing up to 50 transceivers to be connected on the bus.

Excessive power dissipation caused by bus contention or by output shorting is prevented by a thermal shutdown circuit. This feature forces the driver output into a high impedance state if, during fault conditions, a significant temperature increase is detected in the internal driver circuitry.

REV. 0

Information furnished by Analog Devices is believed to be accurate and reliable. However, no responsibility is assumed by Analog Devices for its use, nor for any infringements of patents or other rights of third parties which may result from its use. No license is granted by implication or otherwise under any patent or patent rights of Analog Devices.

FUNCTIONAL BLOCK DIAGRAM

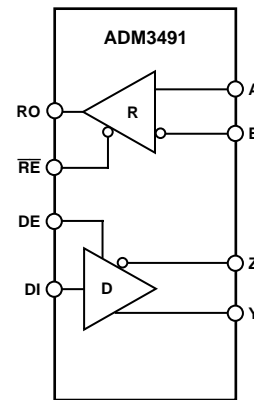

The receiver contains a fail-safe feature that results in a logic high output state if the inputs are unconnected (floating).

The ADM3491 is fabricated on BiCMOS, an advanced mixed technology process combining low power CMOS with fast switching bipolar technology.

The ADM3491 is fully specified over the industrial temperature range and is available in DIP and SOIC packages as well as a new space saving TSSOP package.

ADM3491–SPECIFICATIONS ($V_{CC} = +3.3\text{ V} \pm 0.3\text{ V}$. All specifications T_{MIN} to T_{MAX} unless otherwise noted.)

Parameter	Min	Typ	Max	Units	Test Conditions/Comments
DRIVER					
Differential Output Voltage, V_{OD}	2.0			V	$R_L = 100\ \Omega$, Figure 1, $V_{CC} > 3.1\text{ V}$
	1.5			V	$R_L = 54\ \Omega$, Figure 1
	1.5			V	$R_L = 60\ \Omega$, Figure 2, $-7\text{ V} < V_{TST} < +12\text{ V}$
$\Delta V_{OD} $ for Complementary Output States			0.2	V	$R = 54\ \Omega$ or $100\ \Omega$, Figure 1
Common-Mode Output Voltage V_{OC}			3	V	$R = 54\ \Omega$ or $100\ \Omega$, Figure 1
$\Delta V_{OC} $ for Complementary Output States			0.2	V	$R = 54\ \Omega$ or $100\ \Omega$, Figure 1
CMOS Input Logic Threshold Low, V_{INL}			0.8	V	
CMOS Input Logic Threshold High, V_{INH}	2.0			V	
Logic Input Current (DE, DI, RE)			± 1.0	μA	
Output Leakage (Y, Z) Current			± 3	μA	$V_O = -7\text{ V}$ or $+12\text{ V}$, $V_{CC} = 0\text{ V}$ or 3.6 V
Output Short Circuit Current			± 250	mA	$V_O = -7\text{ V}$ or $+12\text{ V}$
RECEIVER					
Differential Input Threshold Voltage, V_{TH}	-0.2		+0.2	V	$-7\text{ V} < V_{CM} < +12\text{ V}$
Input Voltage Hysteresis, ΔV_{TH}		50		mV	$V_{CM} = 0\text{ V}$
Input Resistance	12	19		k Ω	$-7\text{ V} < V_{CM} < +12\text{ V}$
Input Current (A, B)			+1	mA	$V_{IN} = +12\text{ V}$
			-0.8	mA	$V_{IN} = -7\text{ V}$
Logic Enable Input Current (\overline{RE})			± 1	μA	
Output Voltage Low, V_{OL}			0.4	V	$I_{OUT} = +2.5\text{ mA}$
Output Voltage High, V_{OH}	$V_{CC} - 0.4\text{ V}$			V	$I_{OUT} = -1.5\text{ mA}$
Short Circuit Output Current			± 60	mA	$V_{OUT} = \text{GND}$ or V_{CC}
Three-State Output Leakage Current			± 1.0	μA	$V_{CC} = 3.6\text{ V}$, $0\text{ V} < V_{OUT} < V_{CC}$
POWER SUPPLY CURRENT					
I_{CC}		0.84	1.2	mA	Outputs Unloaded, $DE = V_{CC}$, $\overline{RE} = 0\text{ V}$
		0.84	1.2	mA	$DE = 0\text{ V}$, $\overline{RE} = 0\text{ V}$
Supply Current in Shutdown		0.002	1	μA	$DE = 0\text{ V}$, $\overline{RE} = V_{CC}$

Specifications subject to change without notice.

TIMING SPECIFICATIONS ($V_{CC} = +3.3\text{ V}$, $T_A = +25^\circ\text{C}$)

Parameter	Min	Typ	Max	Units	Test Conditions/ Comments
DRIVER					
Differential Output Delay T_{DD}	1		35	ns	$R_L = 60\ \Omega$, $C_{L1} = C_{L2} = 15\ \text{pF}$, Figure 5
Differential Output Transition Time	1	8	15	ns	$R_L = 60\ \Omega$, $C_{L1} = C_{L2} = 15\ \text{pF}$, Figure 5
Propagation Delay Input to Output T_{PLH} , T_{PHL}	7	22	35	ns	$R_L = 27\ \Omega$, $C_{L1} = C_{L2} = 15\ \text{pF}$, Figure 6
Driver O/P to O/P T_{SKEW}			8	ns	$R_L = 54\ \Omega$, $C_{L1} = C_{L2} = 15\ \text{pF}$, Figure 6
ENABLE/DISABLE					
Driver Enable to Output Valid		45	90	ns	$R_L = 110\ \Omega$, $C_L = 50\ \text{pF}$, Figure 3
Driver Disable Timing		40	80	ns	$R_L = 110\ \Omega$, $C_L = 50\ \text{pF}$, Figure 3
Driver Enable from Shutdown		650	110	ns	$R_L = 110\ \Omega$, $C_L = 15\ \text{pF}$, Figure 3
RECEIVER					
Time to Shutdown	80	190	300	ns	
Propagation Delay Input to Output T_{PLH} , T_{PHL}	25	65	90	ns	$C_L = 15\ \text{pF}$, Figure 8
Skew $T_{PLH} - T_{PHL}$			10	ns	$C_L = 15\ \text{pF}$, Figure 8
Receiver Enable T_{EN}		25	50	ns	$C_L = 15\ \text{pF}$, Figure 4
Receiver Disable T_{DEN}		25	45	ns	$C_L = 15\ \text{pF}$, Figure 4
Receiver Enable from Shutdown			500	ns	$C_L = 15\ \text{pF}$, Figure 4

TIMING SPECIFICATIONS ($V_{CC} = +3.3\text{ V} \pm 0.3\text{ V}$, $T_A = T_{MIN}$ to T_{MAX})

Parameter	Min	Typ	Max	Units	Test Conditions/ Comments
DRIVER					
Differential Output Delay T_{DD}	1		70	ns	$R_L = 60\ \Omega$, $C_{L1} = C_{L2} = 15\ \text{pF}$, Figure 5
Differential Output Transition Time	2	8	15	ns	$R_L = 60\ \Omega$, $C_{L1} = C_{L2} = 15\ \text{pF}$, Figure 5
Propagation Delay Input to Output T_{PLH} , T_{PHL}	7	22	70	ns	$R_L = 27\ \Omega$, $C_{L1} = C_{L2} = 15\ \text{pF}$, Figure 6
Driver O/P to O/P T_{SKEW}			10	ns	$R_L = 54\ \Omega$, $C_{L1} = C_{L2} = 15\ \text{pF}$, Figure 6
ENABLE/DISABLE					
Driver Enable to Output Valid		45	110	ns	$R_L = 110\ \Omega$, $C_L = 50\ \text{pF}$, Figure 3
Driver Disable Timing		40	110	ns	$R_L = 110\ \Omega$, $C_L = 50\ \text{pF}$, Figure 3
Driver Enable from Shutdown		650	110	ns	$R_L = 110\ \Omega$, $C_L = 15\ \text{pF}$, Figure 3
RECEIVER					
Time to Shutdown	50	190	500	ns	
Propagation Delay Input to Output T_{PLH} , T_{PHL}	25	65	115	ns	$C_L = 15\ \text{pF}$, Figure 8
Skew $T_{PLH} - T_{PHL}$			20	ns	$C_L = 15\ \text{pF}$, Figure 8
Receiver Enable T_{EN}		25	50	ns	$C_L = 15\ \text{pF}$, Figure 4
Receiver Disable T_{DEN}		25	50	ns	$C_L = 15\ \text{pF}$, Figure 4
Receiver Enable from Shutdown			600	ns	$C_L = 15\ \text{pF}$, Figure 4

ADM3491

ABSOLUTE MAXIMUM RATINGS*

(T_A = +25°C unless otherwise noted)

V_{CC} +7 V

Inputs

Driver Input (DI) -0.3 V to V_{CC} + 0.3 V

Control Inputs (DE, RE) -0.3 V to V_{CC} + 0.3 V

Receiver Inputs (A, B) -7.5 V to +12.5 V

Outputs

Driver Outputs -7.5 V to +12.5 V

Receiver Output -0.5 V to V_{CC} + 0.5 V

Power Dissipation 14-Lead DIP 800 mW

θ_{JA}, Thermal Impedance 140°C/W

Power Dissipation 14-Lead SOIC 650 mW

θ_{JA}, Thermal Impedance 115°C/W

Power Dissipation 16-Lead TSSOP 500 mW

θ_{JA}, Thermal Impedance 158 °C/W

Operating Temperature Range

Industrial (A Version) -40°C to +85°C

Storage Temperature Range -65°C to +150°C

Lead Temperature (Soldering, 10 sec) +300°C

Vapor Phase (60 sec) +215°C

Infrared (15 sec) +220°C

ESD Rating >2 kV

EFT Rating (IEC1000-4-4) >1 kV

*Stresses above those listed under Absolute Maximum Ratings may cause permanent damage to the device. This is a stress rating only; functional operation of the device at these or any other conditions above those listed in the operational sections of this specification is not implied. Exposure to absolute maximum ratings for extended periods of time may affect device reliability.

ORDERING GUIDE

Model	Temperature Range	Package Description	Package Options
ADM3491AN	-40°C to +85°C	Plastic DIP	N-14
ADM3491AR	-40°C to +85°C	Small Outline (SOIC)	R-14
ADM3491ARU	-40°C to +85°C	Thin Shrink Small Outline (TSSOP)	RU-16

PIN CONFIGURATION

DIP/SOIC

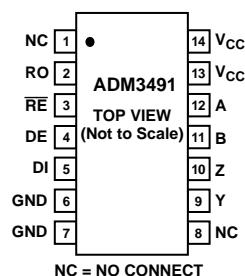

TSSOP

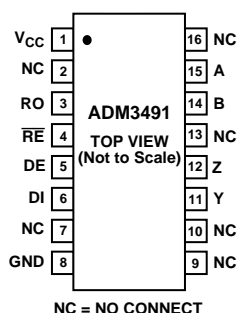

PIN FUNCTION DESCRIPTIONS

Mnemonic Pin	DIP/SOIC	TSSOP	Function
NC	1, 8	2, 7, 9, 10, 13, 16	No Connect.
RO	2	3	Receiver Output. High when $A > B$ by 200 mV or Low when $A < B$ by 200 mV.
\overline{RE}	3	4	Receiver Output Enable. With \overline{RE} low, the receiver output RO is enabled. With \overline{RE} high, the output goes high impedance. If \overline{RE} is high and DE low, the ADM3491 enters a shutdown state.
DE	4	5	Driver Output Enable. A high level enables the driver differential outputs, Y and Z. A low level places it in a high impedance state.
DI	5	6	Driver Input. When the driver is enabled, a logic Low on DI forces Y low and Z high while a logic high on DI forces Y high and Z low.
GND	6, 7	8	Ground Connection, 0 V.
Y	9	11	Noninverting Driver Output Y.
Z	10	12	Inverting Driver Output Z.
B	11	14	Inverting Receiver Input B.
A	12	15	Noninverting Receiver Input A.
V _{CC}	13, 14	1	Power Supply, 3.3 V \pm 0.3 V.

ADM3491

Test Circuits

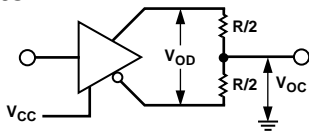

Figure 1. Driver Voltage Measurement Test Circuit

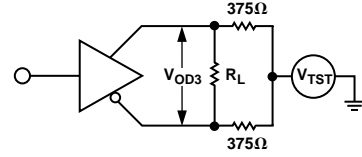

Figure 5. Driver Voltage Measurement Test Circuit 2

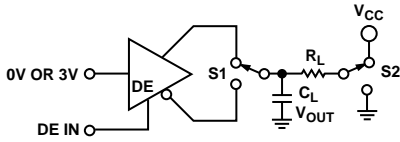

Figure 2. Driver Enable/Disable Test Circuit

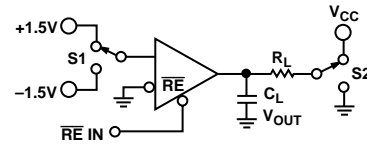

Figure 6. Receiver Enable/Disable Test Circuit

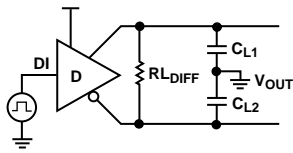

Figure 3. Driver Differential Output Delay Test Circuit

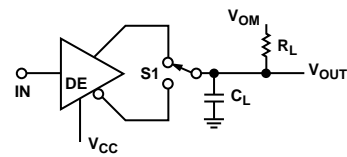

Figure 7. Driver Propagation Delay Test Circuit

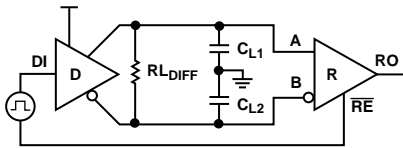

Figure 4. Driver/Receiver Propagation Delay Test Circuit

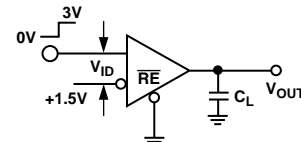

Figure 8. Receiver Propagation Delay Test Circuit

Switching Characteristics

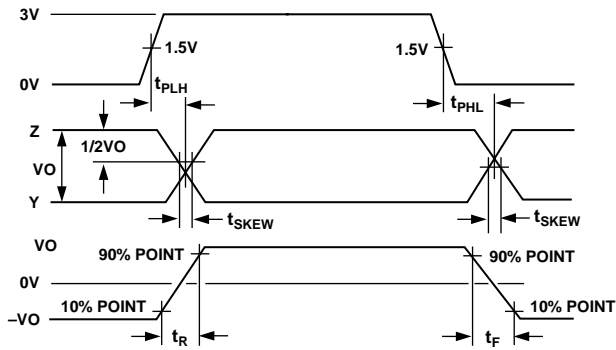

Figure 9. Driver Propagation Delay, Rise/Fall Timing

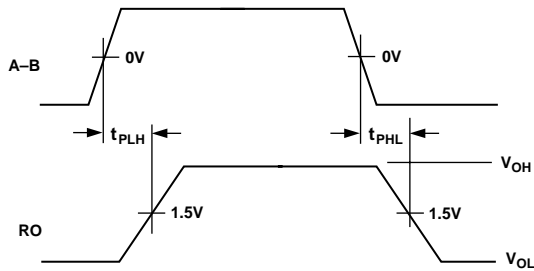

Figure 10. Receiver Propagation Delay

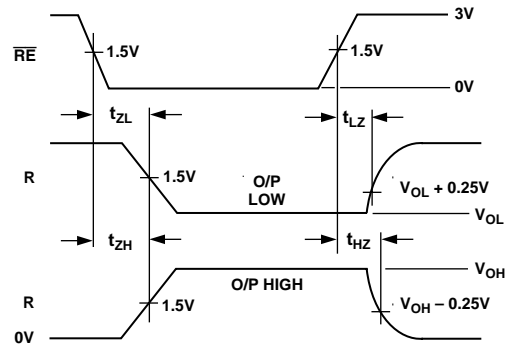

Figure 11. Driver Enable/Disable Timing

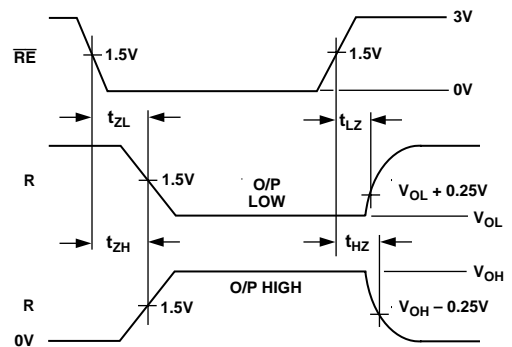

Figure 12. Receiver Enable/Disable Timing

ADM3491–Typical Performance Characteristics

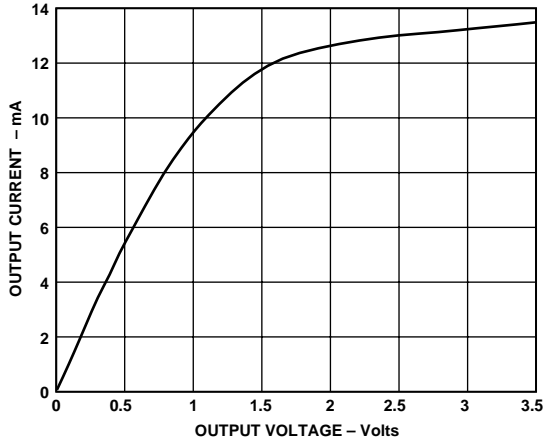

Figure 13. Receiver Output Low Voltage vs. Output Current

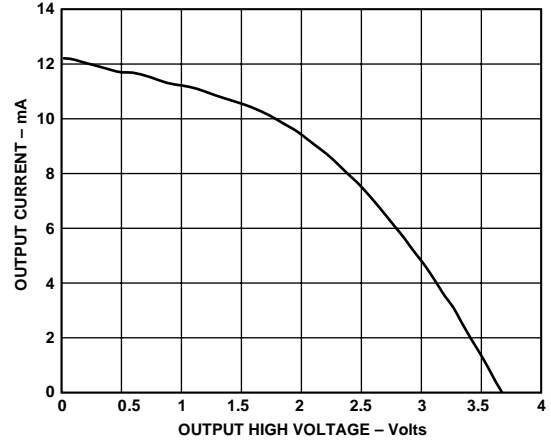

Figure 16. Receiver Output High Voltage vs. Output Current

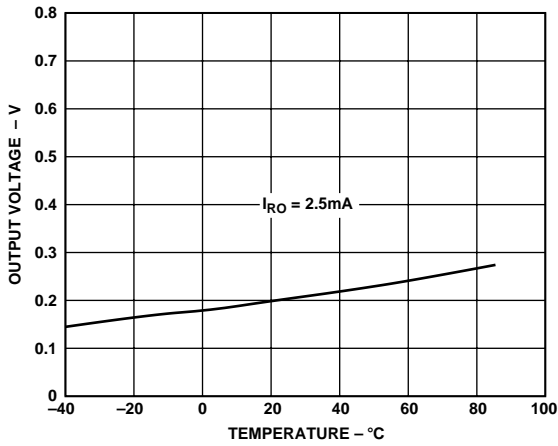

Figure 14. Receiver Output Low Voltage vs. Temperature

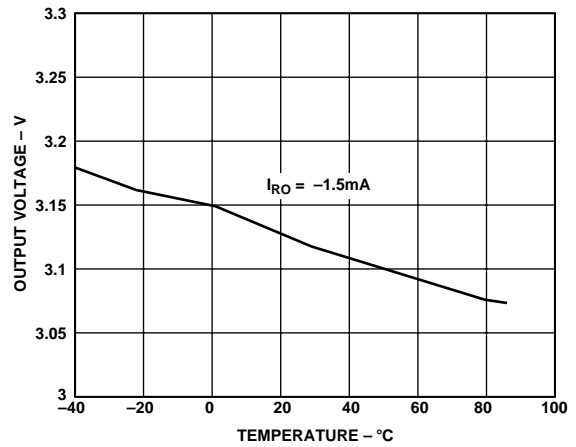

Figure 17. Receiver Output High Voltage vs. Temperature

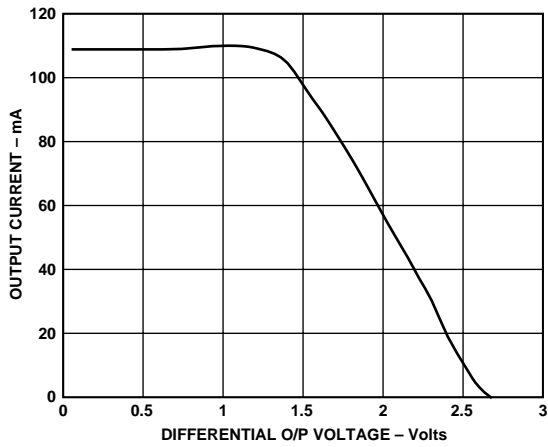

Figure 15. Driver Differential Output Voltage vs. Output Current

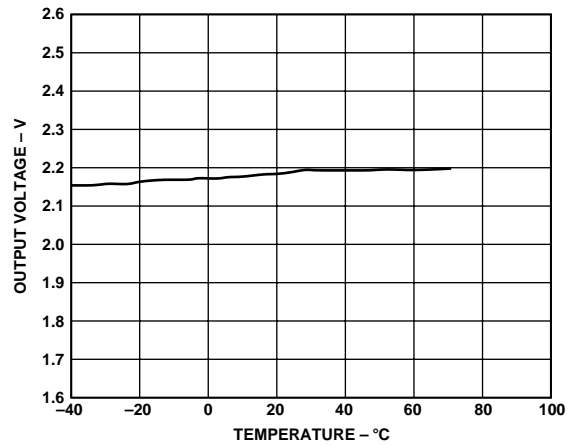

Figure 18. Driver Differential Output Voltage vs. Temperature

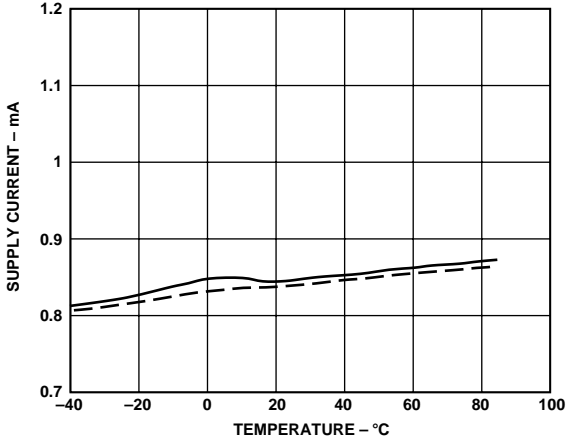

Figure 19. Supply Current vs. Temperature

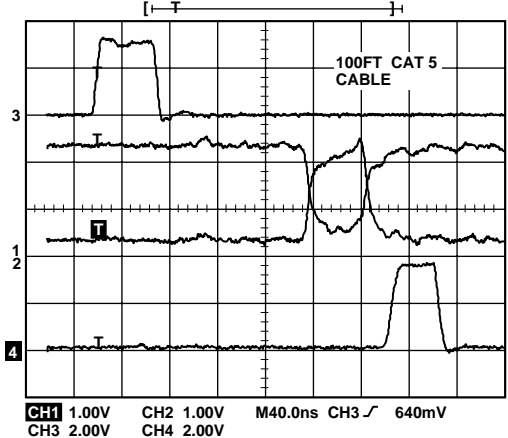

Figure 21. Driving 100 ft. Cable H-L Transition

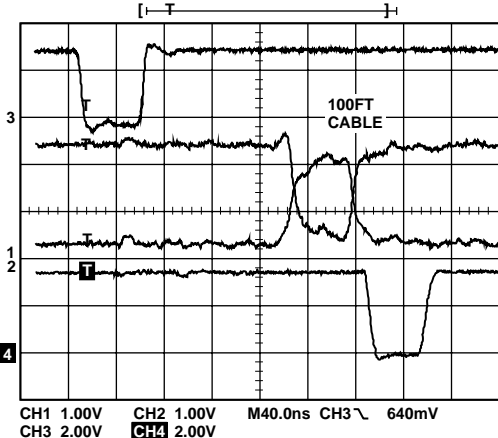

Figure 20. Driving 100 ft. Cable L-H Transition

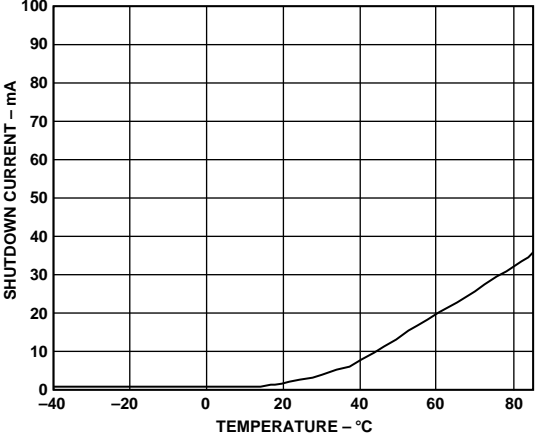

Figure 22. Shutdown Current vs. Temperature

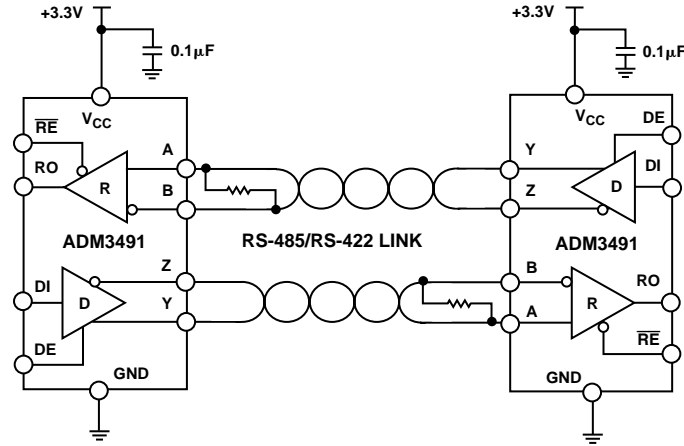

Figure 23. ADM3491 Full-Duplex Data Link

Table I. Transmitting Truth Table

Transmitting				
Inputs			Outputs	
$\overline{\text{RE}}$	DE	DI	Z	Y
X	1	1	0	1
X	1	0	1	0
0	0	X	Hi-Z	Hi-Z
1	0	X	Hi-Z	Hi-Z

Table II. Receiving Truth Table

Receiving			
Inputs			Outputs
$\overline{\text{RE}}$	DE	A-B	RO
0	X	> +0.2 V	1
0	X	< -0.2 V	0
0	X	Inputs O/C	1
1	X	X	Hi-Z

APPLICATIONS INFORMATION**Differential Data Transmission**

Differential data transmission is used to reliably transmit data at high rates over long distances and through noisy environments. Differential transmission nullifies the effects of ground shifts and noise signals which appear as common-mode voltages on the line.

Two main standards are approved by the Electronics Industries Association (EIA) which specify the electrical characteristics of transceivers used in differential data transmission. The RS-422 standard specifies data rates up to 10 MBaud and line lengths up to 4000 ft. A single driver can drive a transmission line with up to 10 receivers.

The RS-485 standard was defined to cater to true multipoint communications. This standard meets or exceeds all the requirements of RS-422, but also allows multiple drivers and receivers to be connected to a single bus. An extended common mode range of -7 V to $+12\text{ V}$ is defined.

The most significant difference between RS-422 and RS-485 is the fact that the drivers may be disabled thereby allowing more than one to be connected to a single line. Only one driver should be enabled at a time, but the RS-485 standard contains additional specifications to guarantee device safety in the event of line contention.

Cable and Data Rate

The transmission line of choice for RS-485 communications is a twisted pair. Twisted pair cable tends to cancel common-mode noise and also causes cancellation of the magnetic fields generated by the current flowing through each wire, thereby reducing the effective inductance of the pair.

The ADM3491 is designed for bidirectional data communications on multipoint transmission lines. A typical application showing a multipoint transmission network is illustrated in Figure 23. Only one driver can transmit at a particular time, but multiple receivers may be enabled simultaneously.

As with any transmission line, it is important that reflections are minimized. This may be achieved by terminating the extreme ends of the line using resistors equal to the characteristic impedance of the line. Stub lengths of the main line should also be kept as short as possible. A properly terminated transmission line appears purely resistive to the driver.

Receiver Open-Circuit Fail Safe

The receiver input includes a fail-safe feature that guarantees a logic high on the receiver when the inputs are open circuit or floating.

Table III. Comparison of RS-422 and RS-485 Interface Standards

Specification	RS-422	RS-485
Transmission Type	Differential	Differential
Maximum Cable Length	4000 ft.	4000 ft.
Minimum Driver Output Voltage	$\pm 2\text{ V}$	$\pm 1.5\text{ V}$
Driver Load Impedance	100 Ω	54 Ω
Receiver Input Resistance	4 k Ω min	12 k Ω min
Receiver Input Sensitivity	$\pm 200\text{ mV}$	$\pm 200\text{ mV}$
Receiver Input Voltage Range	-7 V to $+7\text{ V}$	-7 V to $+12\text{ V}$

OUTLINE DIMENSIONS

Dimensions shown in inches and (mm).

**14-Lead Plastic DIP
(N-14)**

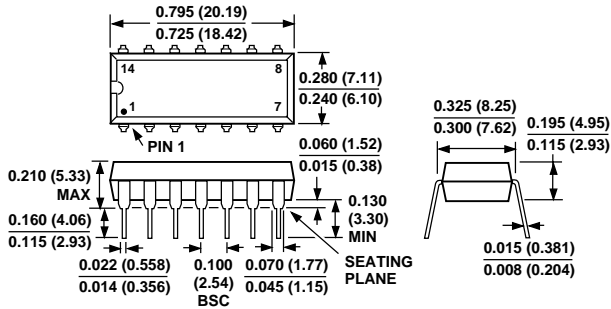

**14-Lead Narrow Body Small Outline (SOIC)
(R-14)**

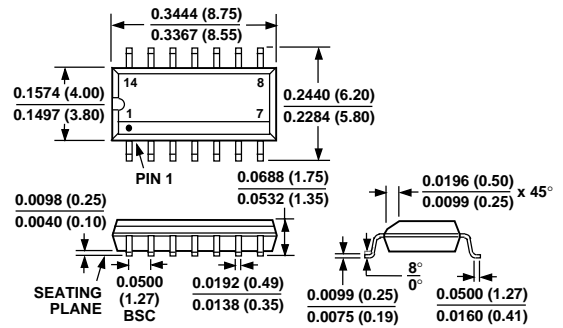

**16-Lead Thin Shrink Small Outline (TSSOP)
(RU-16)**

