

CLM4102 / CLM4302

FEATURES

- Improved Replacement for EL2002
- Slew Rate 11000V/ μ s
- Wide Bandwidth..... 400MHz
- Output Current..... 150mA
- Wide Supply Voltage..... $\pm 3V$ to $\pm 18V$
- Supply Current..... 5mA
- Short Circuit Product
- Low Bias Current

APPLICATIONS

- Op Amp Booster
- Coaxial Cable Driver
- A/D Input Buffer
- Isolation Buffer

GENERAL DESCRIPTION

The CLM4102 product family is a low power, wide bandwidth buffer amplifier. The 4102 family delivers a -3dB bandwidth of 400MHz, 200mA, and 11000V/ μ s while only drawing 5mA of supply current. The CLM4102 family operates over a wide supply voltage range of $\pm 3V$ to $\pm 18V$.

This product is an excellent choice for coaxial cable drivers, A/D converter input buffers and fast op-amp current boosters, in applications for video, test and medical systems and military designs.

ORDERING INFORMATION

Part	Package	Temperature Range
CLM4102M	SOIC 20-Lead	-40°C to +85°C
CLM4102N	Plastic Dip 8-Lead	-40°C to +85°C
CLM4302M	SOIC 20-Lead	-25°C to +85°C
CLM4302N	Plastic Dip 8-Lead	-25°C to +85°C

CONNECTION DIAGRAMS

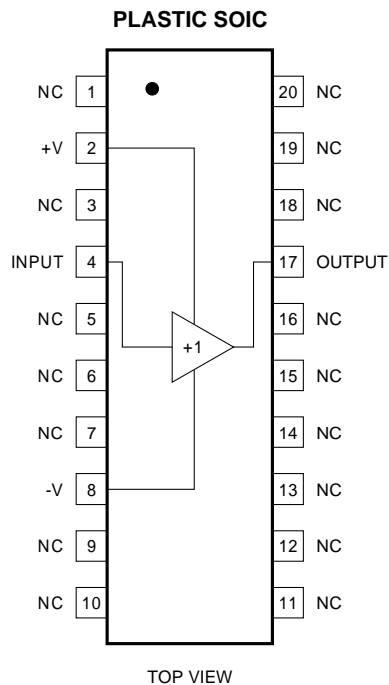
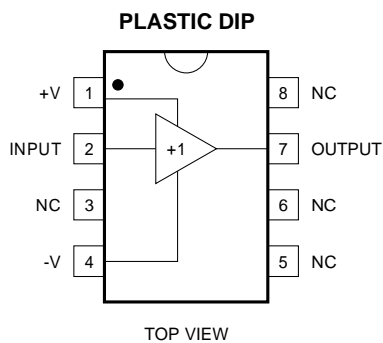

ABSOLUTE MAXIMUM RATINGS (Note 1)

Supply Voltage	±20V
Input Voltage	±V _{supply}
Storage Temperature Range	-65°C to +150°C
Lead Temperature (Soldering 10 seconds)	260°C
Power Dissipation	(Note 4)
ESD Tolerance (Note 3)	±2000V

Thermal Resistance (θ_{JA})	
N Package	95°C/W
M Package	95°C/W
Thermal Resistance (θ_{JC})	
N Package	50°C/W
M Package	50°C/W
Maximum Junction Temperature	150°C

DC ELECTRICAL CHARACTERISTICS

The following specifications apply for Supply Voltage = ±15V, $V_{CM} = 0$, $R_L \geq 100K\Omega$ and $R_S = 50\Omega$ unless otherwise noted. **Boldface** limits apply for $T_A = T_J = T_{MIN}$ to T_{MAX} ; all other limits $T_A = T_J = 25^\circ C$.

SYMBOL	CHARACTERISTICS	TYP	CLM4102	CLM4302	UNITS	CONDITIONS
			Limit (Note 5)	Limit (Note 5)		
A _{V1}	Voltage Gain 1	0.99	0.96 0.96	0.95 0.95	V/V Min	R _L = ∞, V _{IN} = ±12V
A _{V2}	Voltage Gain 2	0.95	0.90 0.90	0.90 0.90		R _L = 100Ω, V _{IN} = ±10V
A _{V3}	Voltage Gain 3	0.92	0.85 0.85	0.85 0.85		R _L = 100Ω, V _{IN} = ±3V, V _S = ±5V
V _{OS}	Offset Voltage	10	15 20	30 40	mV Max	R _L = ∞
I _B	Input Bias Current	1	8 10	12	μA Max	R _L = ∞
R _{IN}	Input Resistance	0.5	.2	.2	MΩ	R _L = 100Ω
C _{IN}	Input Capacitance	3.5			pF	
R _O	Output Resistance	3	7	10	Ω Max	R _L = 100Ω, V _{IN} = ±2V
I _S	Supply Current	5	7.5	7.5	mA Max	R _L = ∞
V _O	Output Swing	10	10	10	±V Min	R _L = 100Ω, V _{IN} = ±12V
I _{OUT}	Output Current	200	100	100	mA	V _{IN} = 12V

AC ELECTRICAL CHARACTERISTICS

The following specifications apply for Supply Voltage = $\pm 15V$, $V_{CM} = 0$, $R_L \geq 100K\Omega$ and $R_S = 50\Omega$ unless otherwise noted. **Boldface** limits apply for $T_A = T_J = T_{MIN}$ to T_{MAX} ; all other limits $T_A = T_J = 25^\circ C$.

SYMBOL	CHARACTERISTICS	TYP	CLM4102	CLM4302	UNITS	CONDITIONS
			Limit (Note 5)	Limit (Note 5)		
SR ₁	Slew Rate 1	11000	8000	6000	V/ μ s	$V_{IN} = \pm 10V$, $R_L = 100\Omega$ (Note 2)
SS _{BW}	Small Signal Bandwidth	400	200	200	MHz	$V_{IN} = \pm 100mV_{PP}$, $R_L = 100\Omega$ $C_L \leq 10pF$
P _{BW}	Power Bandwidth	100				$V_{IN} = \pm 4V$, $R_L = 100\Omega$ $C_L \leq 10pF$
t _r , t _f	Rise Time Fall Time	1.2	1.7	1.7	ns	$R_L = 100\Omega$, $C_L \leq 10pF$ $V_{IN} = 0.5V$
t _{pd}	Propagation Delay Time	2.0			ns	$R_L = 100\Omega$, $C_L \leq 10pF$ $V_{IN} = 0.5V$

Note 1: Absolute Maximum Ratings indicate limits beyond which damage to the device may occur. DC and AC electrical specifications do not apply when operating the device beyond its rated operating conditions.

Note 2: Slew rate is measured with 50Ω source impedance at $25^\circ C$. Slew rate is measured between $V_O = +5V$ and $-5V$.

Note 3: The test circuit consists of the human body model of $120pF$ in series with 1500Ω .

Note 4: The maximum power dissipation is a function of $T_{J(max)}$, θ_{JA} and T_A . The maximum allowable power dissipation at any ambient temperature is $P_D = (T_{J(max)} - T_A)/\theta_{JA}$.

Note 5: Limits are guaranteed by testing, correlation or periodic characterization.

TYPICAL PERFORMANCE CHARACTERISTICS

SLEW RATE vs LOAD CAPACITANCE

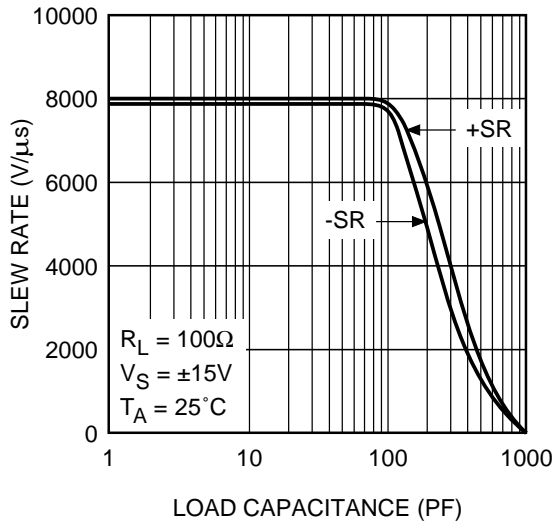

PHASE SHIFT vs FREQUENCY FOR VARIOUS CAPACITIVE LOADS

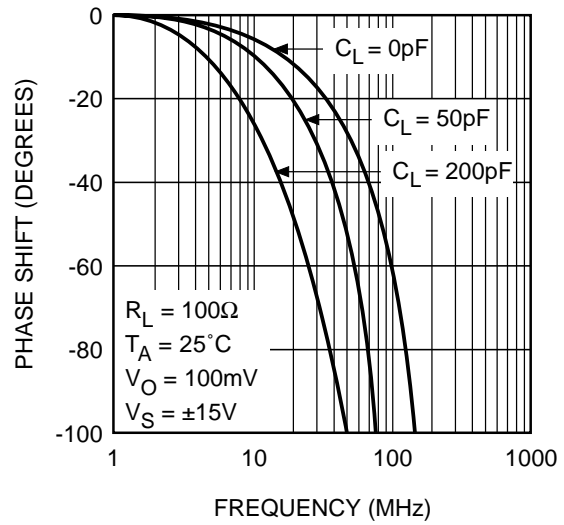

VOLTAGE GAIN vs FREQUENCY FOR VARIOUS RESISTIVE LOADS

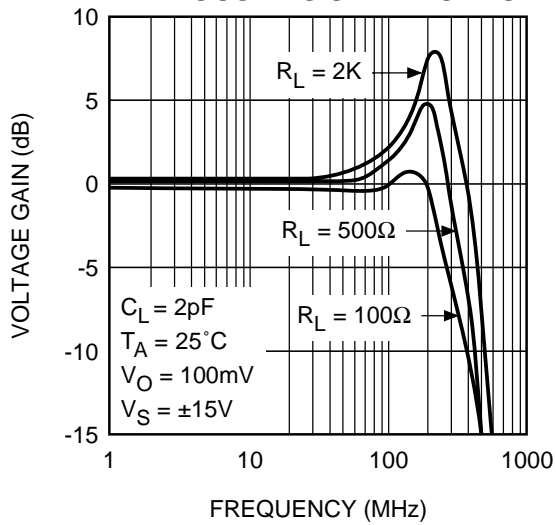

-3dB BANDWIDTH vs SUPPLY VOLTAGE

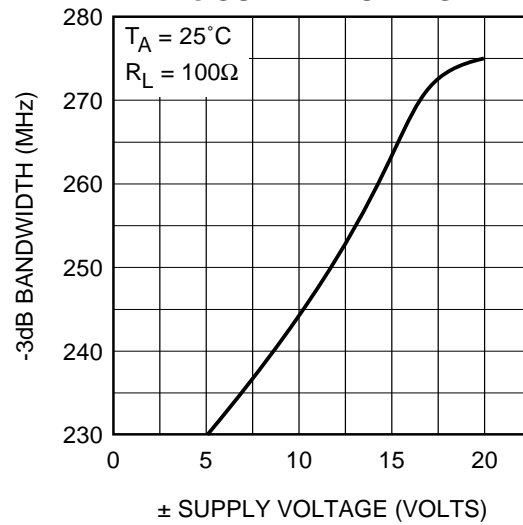

TYPICAL PERFORMANCE CHARACTERISTICS (continued)

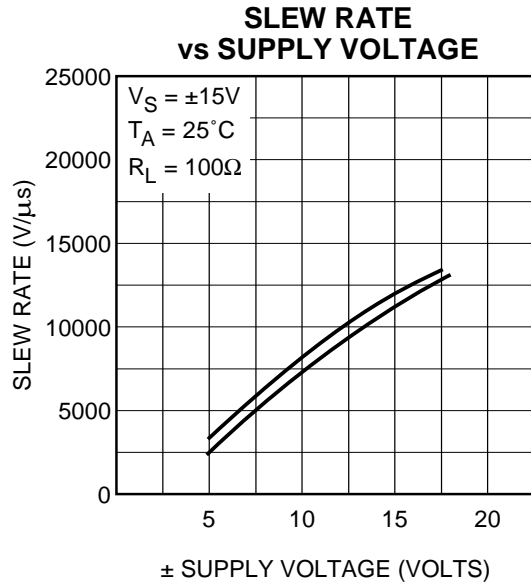
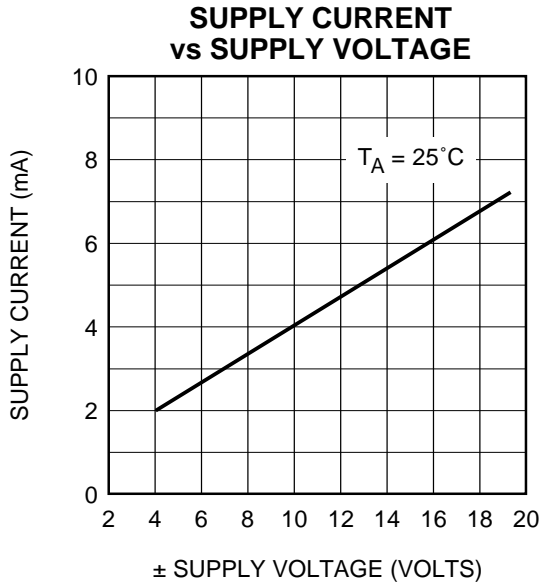

VOLTAGE GAIN vs FREQUENCY FOR VARIOUS CAPACITIVE LOADS, $R_L = 100\Omega$

