

GENERAL DESCRIPTION

The EM32100 is a CMOS LCD display driver which can receive dialing data from dialer IC and display on the LCD panel. The EM32100 can also display real time clock, conversation time (stopwatch).

FEATURES

- Drive 8/10 digits LCD panel.
- Display dialing number.
- Display real time clock (RTC) in 12 hour or 24 hour format selectable.
- Stopwatch function for counting conversation time up to 59 minutes 59 seconds.
- Operating voltage: 1.5 VDC (typical)
- Operating current : 3 μ A (max.)
- LCD driver method : 1/3 duty , 1/2 bias.
- Internal voltage doubler circuit for drive LCD.
- Internal dialer interface.
- Use single colck 32768Hz crystal.
- Package in QFP 48 pins or chip form .

APPLICATION FIELD

Telephone and Digital display system.

PIN ASSIGNMENTS

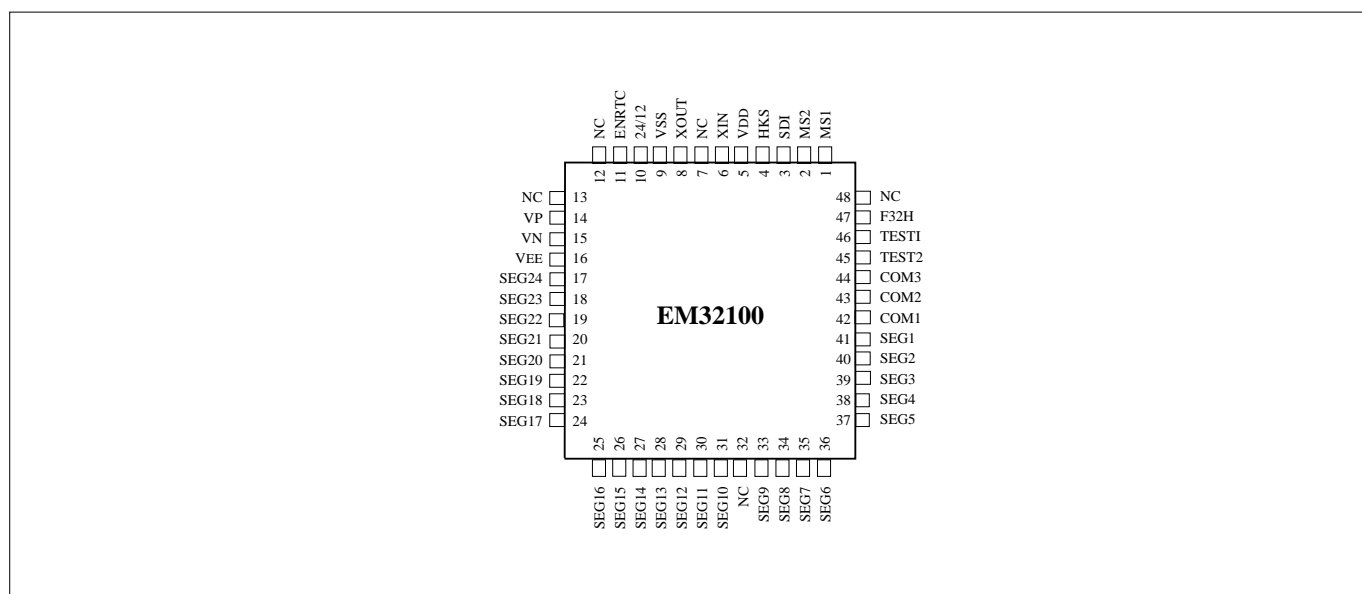

FUNCTION BLOCK DIAGRAM

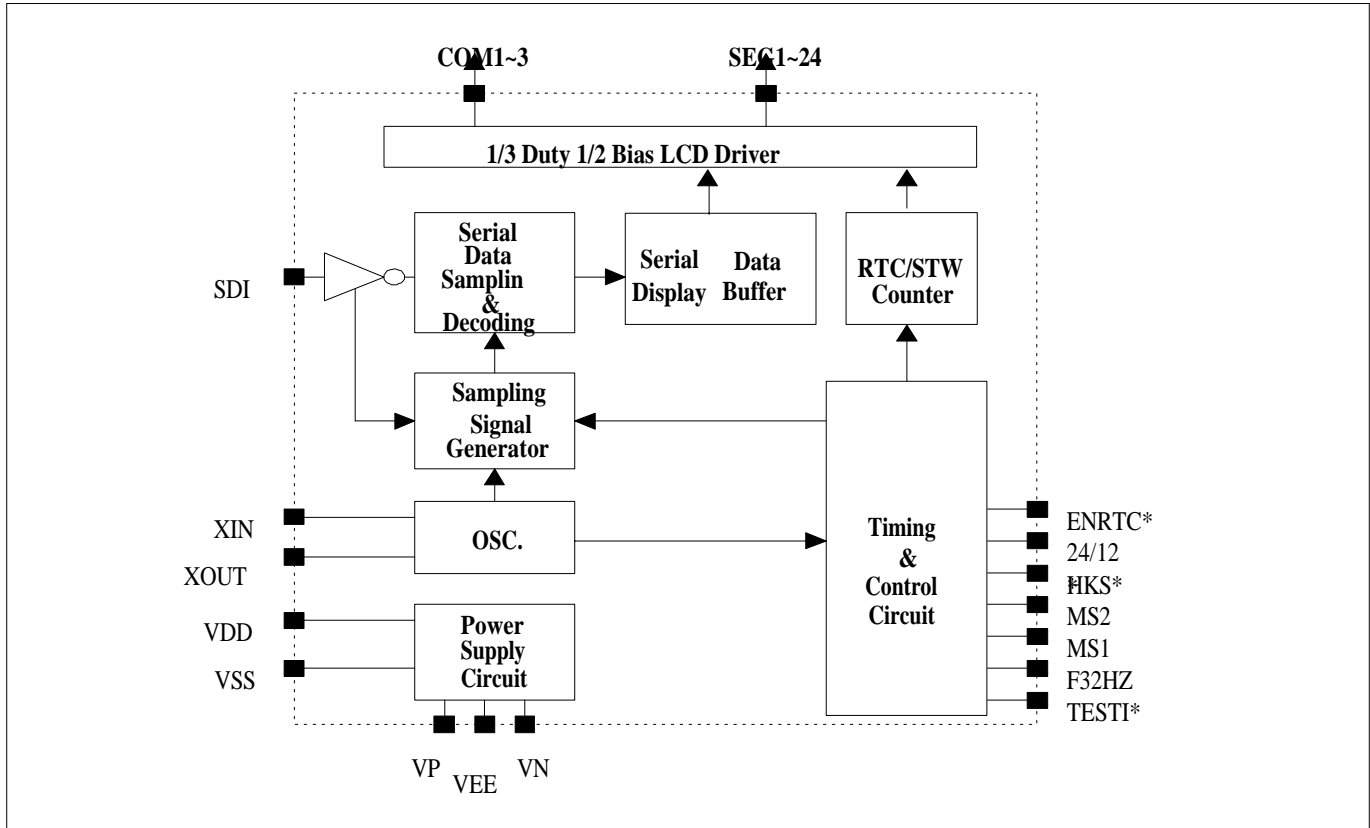

PIN DESCRIPTIONS

Symbol	Function
MS1	RTC (Real Time Clock) manual setting pin 1 (internal pull up resistor typ. 150k Ω ,debounce time=15.6ms)
MS2	RTC (Real Time Clock) manual setting pin 2 ; internal pull up resistor : idle (On-Hook) = 5M Ω , normal (Off- Hook) = 150k Ω ; at idle and normal state , debounce time=15.6ms , at test mode state , no debounce time)
SDI	Serial data input pin (internal pull up resistor = 5 M Ω)
HKS	Hook switch status input pin. (This pin "High",On-Hook ; "Low",Off-Hook)
V _{DD}	Power supply pin
XIN,XOUT	Crystal input and output pins(crystal=32768Hz)
V _{SS}	Power supply pin
24/12	RTC display 24 or 12 hours format select pin.(This pin "high",24 hours form;"low",12 hours form,input pin)
ENRTC	RTC enable or disable detect pin. (This pin detect "high", RTC disable; "low" , RTC enable , input pin)
VEE,VP,VN	Voltage doubler circuit for LCD driver (DC-DC frequency conversion=1024Hz)
SEG1~SEG24	LCD panel driver segment output pins
COM1~COM3	LCD panel driver common output pins (Frame Frequency= 34.13 Hz).
TEST2	No connection , reserve for testing
TESTI	Enter test mode detect pin
F32H	Signal 32 Hz output for testing ,NMOS open drain structure

The relationship between ENRTC and EM32100 system LCD display method is as follows:

	ON-HOOK (HKS="High")	OFF-HOOK(HKS="Low")
ENRTC="High"	blank	dialing number STW
ENRTC="Low"	RTC	dialing number STW RTC

LCD Panel Description

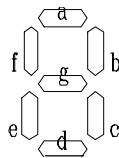

	SEG24	SEG23	SEG22	SEG21	SEG20	SEG19	SEG18	SEG17
COM3	9a	10f	10b	9f	9b	8f	8b	6a
COM2	8a	10e	10g	9e	9g	8e	8g	5a
COM1	10a	10d	10c	9d	9c	8d	8c	7a

	SEG16	SEG15	SEG14	SEG13	SEG12	SEG11	SEG10	SEG9
COM3	7f	7b	6f	6b	5f	5b	3a	4f
COM2	7e	7g	6e	6g	5e	5g	2a	4e
COM1	7d	7c	6d	6c	5d	5c	4a	4d

	SEG8	SEG7	SEG6	SEG5	SEG4	SEG3	SEG2	SEG1
COM3	4b	3f	3b	2f	2b	1f	1b	AM
COM2	4g	3e	3g	2e	2g	1e	1g	PM
COM1	4c	3d	3c	2d	2c	1d	1c	1a

COM:

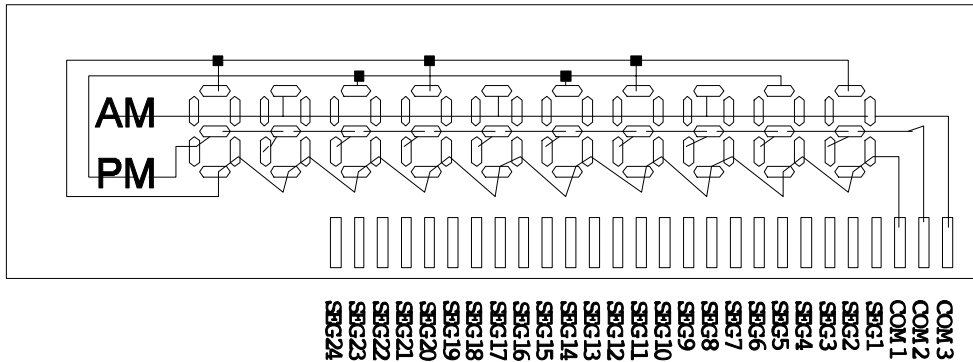

SEG:

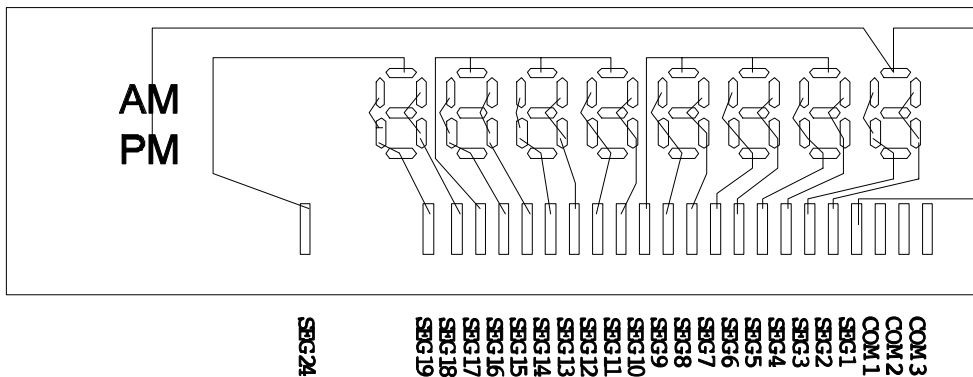
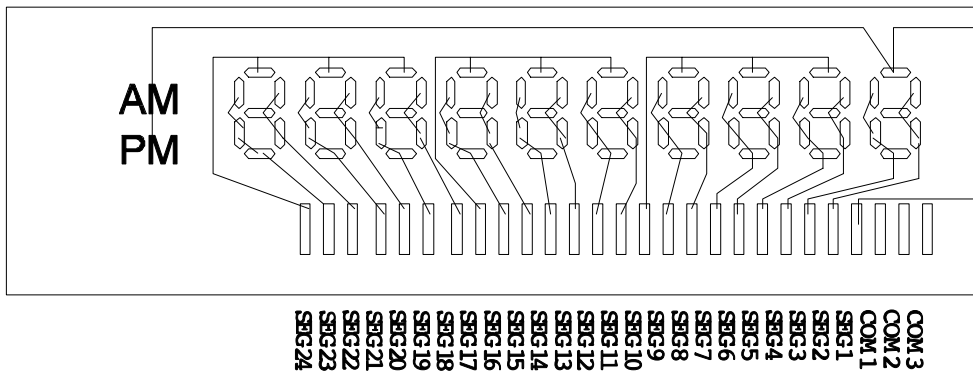

<Note>:

If SEG20~23 are not used, then it can be used as an 8 digits LCD display driver.

Serial Data Interface

When the EM32100 senses the falling edge of the Start bit, it will sample subsequent bits in the middle of each bit. The received bit will then be assembled and decoded, and corresponding pattern will be displayed on LCD panel. The serial data format is as follows:

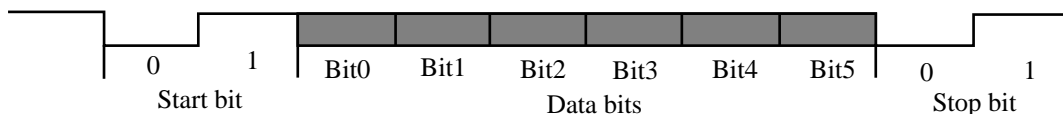

The frequency of every bit is 256Hz (about 3.9 ms)

There are two categories of dialing data, and representation of serial data is as the following:

* This specification are subject to be changed without notice.

(b5b4 = 00) Digit key

Key	1	2	3	4	5	6	7	8	9	0	*	#	P	P→T
b3b2b1b0	0001	0010	0011	0100	0101	0110	0111	1000	1001	1010	1011	1100	1101	1110
Display	1	2	3	4	5	6	7	8	9	0	⌞	⌞	P	└─

(b5b4 = 10) function key

Key	F
b3b2b1b0	1111
Display	

Note:

1. Flash key will be treated as "clear LCD panel" command.
2. Any invalid data will be ignored by the EM32100.

FUNCTION DESCRIPTION

Dialing display

The serial data received by SDI pin of EM32100 will be decoded and shown on LCD panel. Display format is as follows:

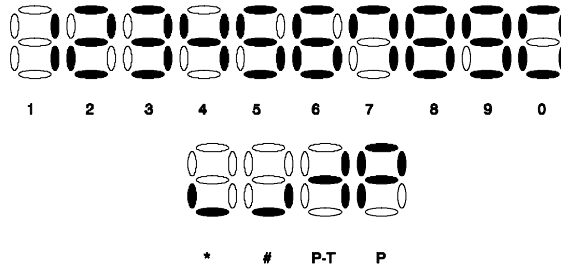

Off-Hook state mode:

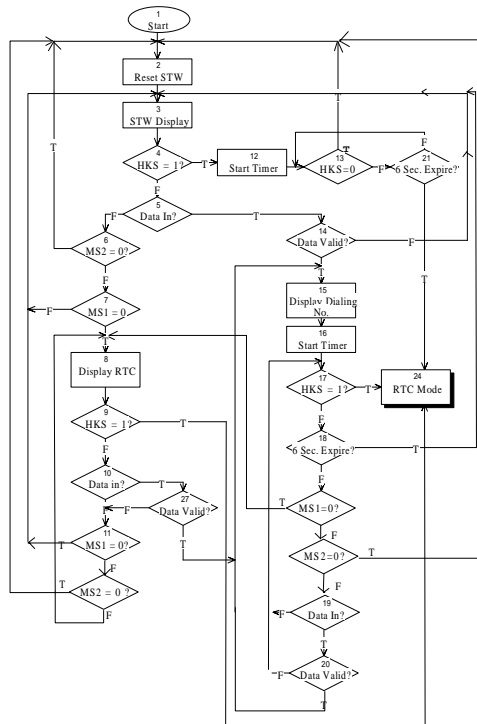

RTC (Real time clock) display

12 hours format:

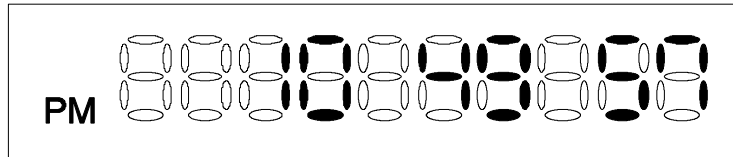
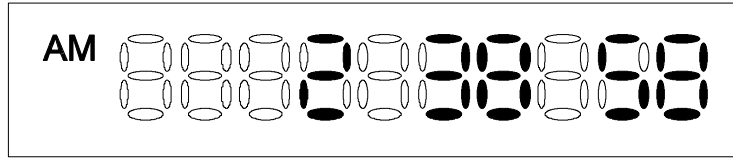

24 hours format:

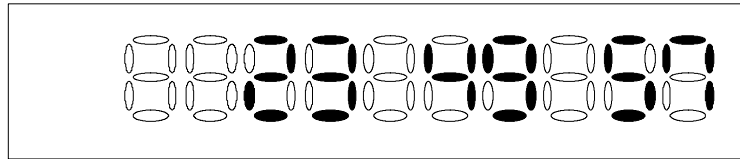
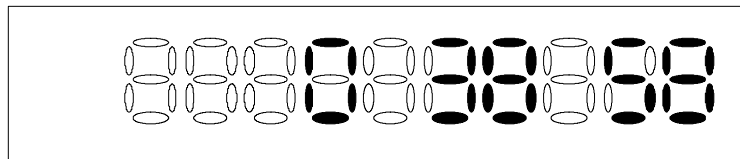

<Note>:

12 or 24 hours format is selected by 24/12 pin. When this pin is pulled "high", then RTC is displayed in 24 hours format, otherwise RTC is displayed in 12 hours format. The AM, PM patterns will not show for RTC display in 24 hours format.

STW (stop watch) display

When HKS pin is high, the system work in RTC display mode .When HKS pin switches from "high" to "low", the system enter STW display mode.STW count up from 00:00 up to 59:59. For example:

HKS="HIGH"

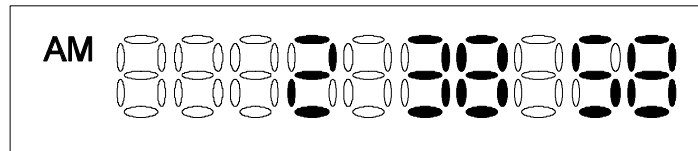

HKS="LOW"

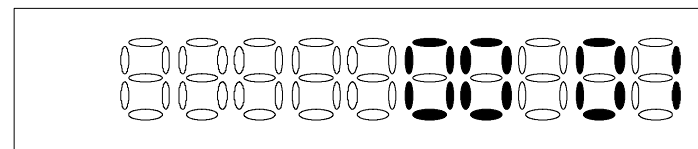
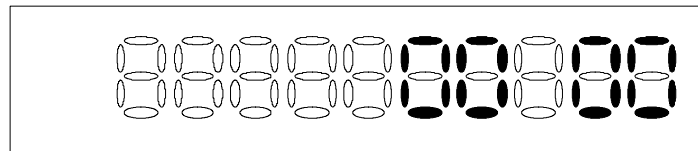

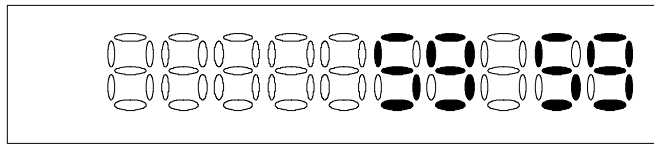

MS2="LOW"

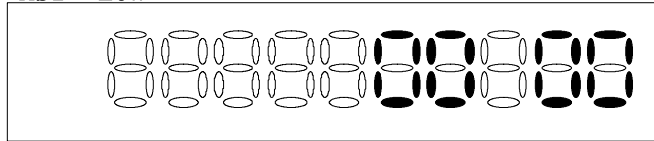

MS2="HIGH"

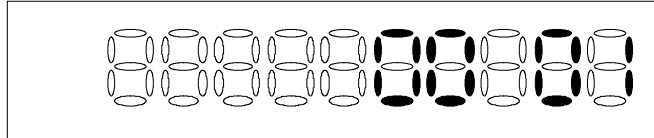

Setting RTC

With the HKS pin at "high", RTC can be set up by operating MS1 and MS2 pins as described as in the following:

1. In on-Hook state, press MS1, hour digit will flash,
2. Press MS2 to count up data.
3. Press MS1 once again, move to minute digit, digit flash, and reset second.
4. Press MS2 to count up minute digit.
5. Press MS1 again to finish RTC set up.

<Note>:

1. If MS2 are pressed and hold for over 2 sec ,then data automatically count up in every 0.5 sec.
2. Digit flash time is 1 Hz (0.5 sec on, 0.5 sec off)

RTC setup Flowchart:

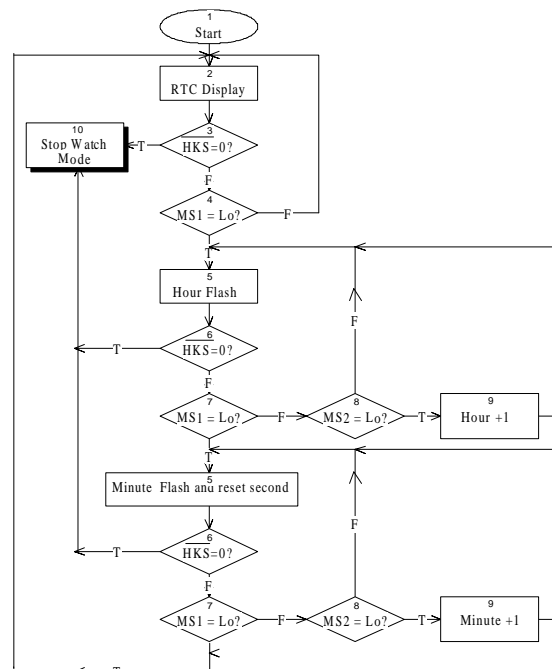

RTC display and STW reset at Off-hook state

1. When at On-hook state, operating MS1 and MS2 can setup RTC.
2. When at Off-hook state, operating MS1 and MS2 can display RTC and clear STW.

Describe as following table:

	HKS="high"	HKS="low"
MS1	Select RTC setup position	Toggle display RTC/STW
MS2	Count up hour or minute data	Reset STW

Testing operating

The F32HZ pin is a 32 Hertz clock source. This pin is intended to support LCD module testing in production line in the following two ways:

1. F32HZ can be connected to MS2 pin and, by operating the MS1 pin, can be used to test RTC setting function.
2. At off-HOOK state; In the TEST mode (the TEST pin is at "Low" level), the SDI pin sampling signal frequency is 32 Hz. F32HZ pin can be connected to SDI pin and with each reception of SDI data of "0" key, the LCD will display "1", "2", ..., "9", *, #, P,P→T with each digit shifted left sequentially. Then the LCD panel goes blank, AM,PM goes on, and finally all patterns go on. And this sequence will repeat again.

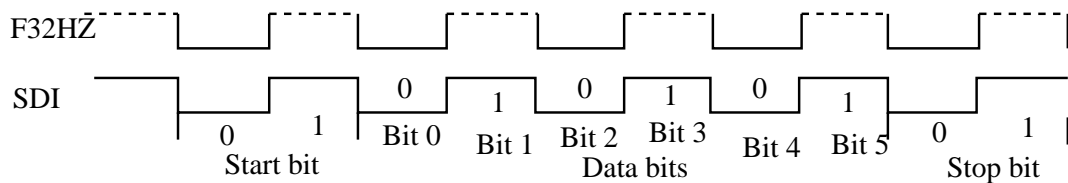

- After entering test mode and 6 digits of "0" are received, the LCD panel is as follows:

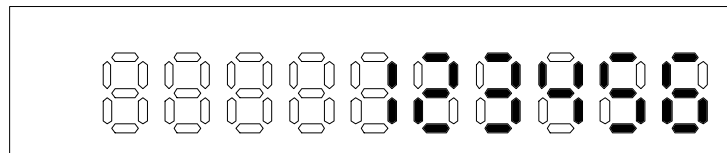

- Then 8 more digits of "0" are received, the LCD panel is as follows:

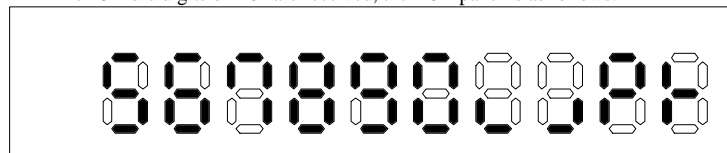

- Then the LCD panel will go blank.

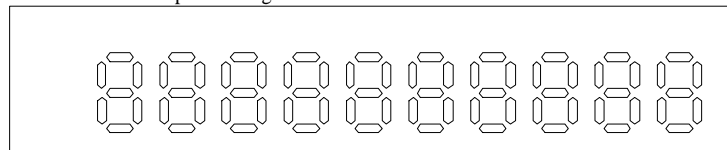

- Turn on “AM” indicator

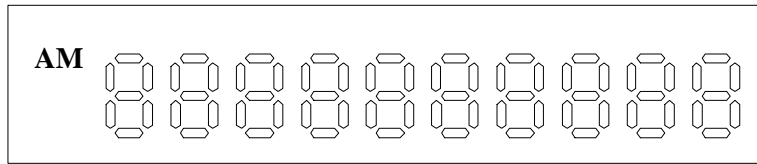

- Then turn on “PM” indicator

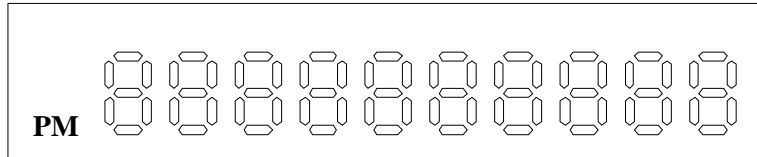

- Finally all patterns are turned on.

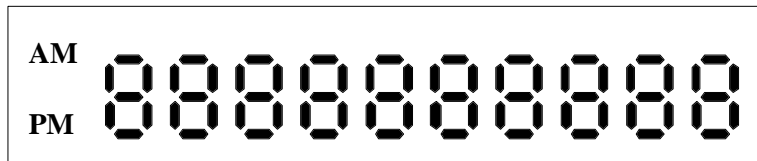

- Then the sequence will repeat all over again.

ABSOLUTE MAXIMUM RATINGS

Items	Sym.	Condition	Rating
Supply voltage	V_{DD}		- 0.5V to 1.5V
Input voltage	V_{IN}		- 0.5V to $V_{DD}+0.5V$
Output voltage	V_O	Except open-drain Open-drain	- 0.5V to $V_{EE}+0.5V$ -0.5 V to 3V
Output current	I_O	Others	3.2 mA
Power dissipation	P_D	$T_{OPR} = 50^{\circ}C$	300 mW
Operating temperature	T_{OPR}		0°C to 50°C
Storage temperature	T_{STR}		-55°C to 125°C

RECOMMENDED OPERATING CONDITIONS

1. Supply voltage at 1.5V D.C.
2. Operation frequency f_{osc} : 32768 Hz.

DC AND AC ELECTRICAL CHARACTERISTICS ($f_{osc}=32768\text{ Hz}, V_{DD}=1.5\text{V}$)

Parameter	Sym.	Condition	Min.	Typ.	Max.	Unit
Operating voltage	V_{DD}		1.2	1.5	1.8	V
	V_{EE}		2.4	3	3.6	V
Operating current (no load)	I_{DD}		-	1.5	3	μA
Power on crystal start oscillation voltage	V_{START}		1.3	1.5	1.8	V
Input voltage	V_{IH}		$V_{DD}-0.3$	-	V_{DD}	V
	V_{IL}		V_{SS}	-	$V_{SS}+0.3$	V
Standby current (ENRTC=H)	I_{STBY}		-	-	1	μA
Input pins pull-up resistor (MS1, TestI pins)	R_I		-	150	-	$\text{K}\Omega$
MS2 pin input resistance	R_I	HKS=1, $V_I=V_{SS}$	-	5	-	$\text{M}\Omega$
		HKS=0, $V_I=V_{SS}$	-	150	-	$\text{K}\Omega$
SDI pin input resistance	R_I	$V_{IN}=V_{SS}$	-	5	-	$\text{M}\Omega$
SDI input data every bit time	T_{BIT}		3.8	3.9	4.1	mS
Oscillator frequency	fosc.		-	32768	-	Hz
Oscillator start time	T_{START}	$V_{DD}=1.45$	-	-	2	Sec.
Common/Segment pins						
Source current	I_{OH}	$V_O=V_{EE}-0.5\text{V}$	6	-	-	μA
Sink current	I_{OL}	$V_O=0.5$	6	-	-	μA
F32HZ pin sink current	I_S	$V_O=0.5\text{V}$	0.2	0.5	-	mA
HKS, MS1, TESTI, MS2 (not at test mode), input pin debouce time	Tdb	$V_O=0.5\text{V}$	-	15.6	-	mS

PAD DIAGRAM

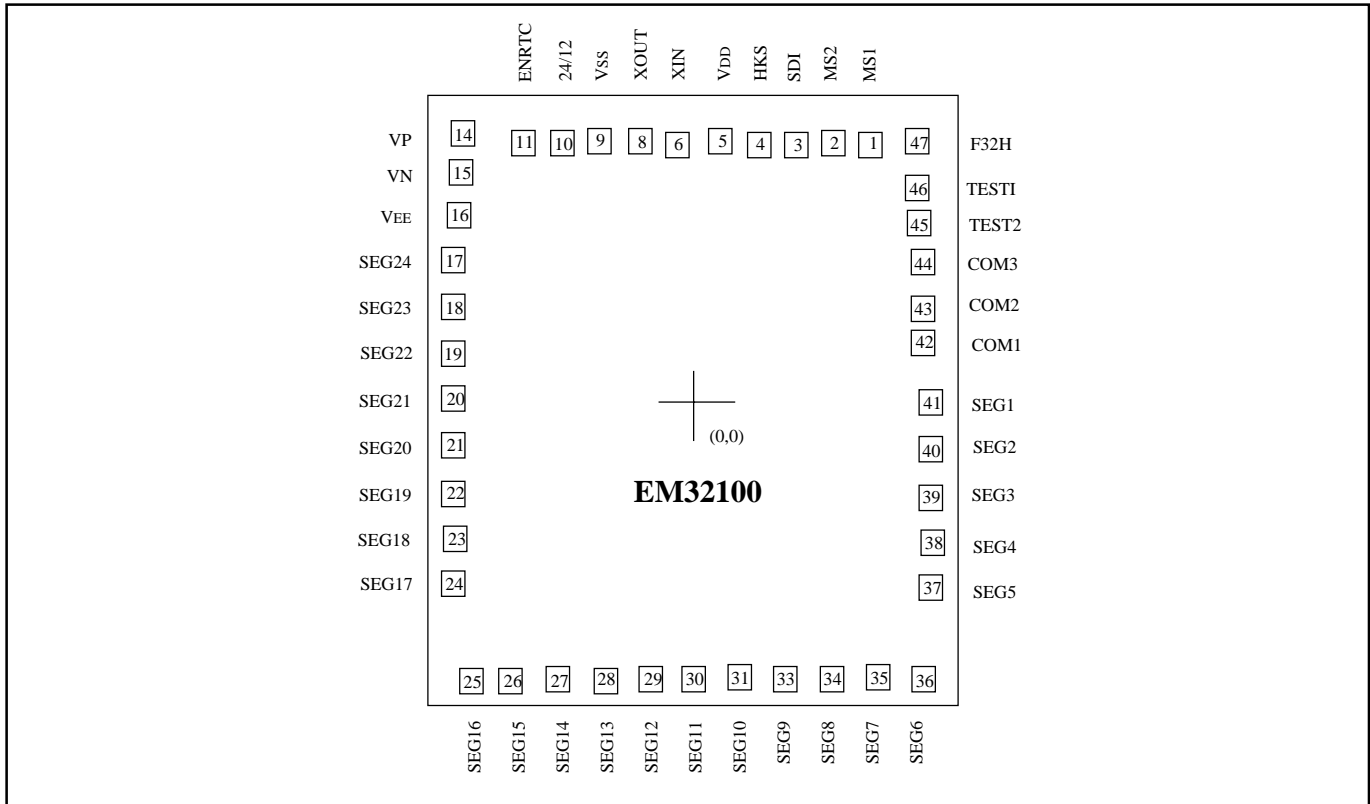

Chip Size : 2230 x 2480 μm

Pad No.	Symbol	X	Y
1	MS1	712.8	992.2
2	MS2	561.6	992.2
3	SDI	412.2	992.2
4	HKS	261.0	992.2
5	V _{DD}	103.5	1012.0
6	XIN	-59.5	992.2
7			
8	XOUT	-209.8	1006.2
9	V _{SS}	-371.8	1006.2
10	24/12	-523.9	992.2
11	ENRTC	-673.3	992.2
12			
13			
14	VP	-917.2	1033.6
15	VN	-917.2	884.2
16	V _{EE}	-931.2	733.3
17	SEG24	-949.2	552.1
18	SEG23	-949.2	371.7
19	SEG22	-949.2	191.3
20	SEG21	-949.2	11.0

* This specification are subject to be changed without notice.



Pad No.	Symbol	X	Y
21	SEG20	-949.2	-169.4
22	SEG19	-949.2	-349.7
23	SEG18	-949.2	-530.1
24	SEG17	-949.2	-710.5
25	SEG16	-895.7	-1074.2
26	SEG15	-715.3	-1074.2
27	SEG14	-535.0	-1074.2
28	SEG13	-354.6	-1074.2
29	SEG12	-174.2	-1074.2
30	SEG11	6.1	-1074.2
31	SEG10	186.5	-1074.2
32			
33	SEG9	366.8	-1074.2
34	SEG8	547.2	-1074.2
35	SEG7	727.6	-1074.2
36	SEG6	907.9	-1074.2
37	SEG5	949.1	-723.1
38	SEG4	949.1	-542.7
39	SEG3	949.1	-362.3
40	SEG2	949.1	-182.0
41	SEG1	949.1	-1.6
42	COM1	917.1	237.0
43	COM2	917.1	388.2
44	COM3	917.1	539.4
45	TEST2	903.1	695.6
46	TEST1	903.1	845.0
47	F32H	903.1	996.2
48			