

# 20 kRAD RADIATION TOLERANT 3 AMP NEGATIVE ADJUSTABLE VOLTAGE REGULATORS

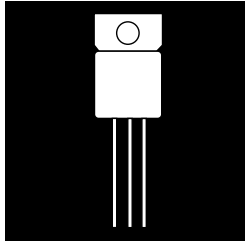

**Three Terminal, Adjustable Voltage, 3.0 Amp  
Precision Negative Regulators In Hermetic  
JEDEC TO-257AA Package**

## FEATURES

- Available in Three Hermetic Package Styles
- Radiation Tolerant up to 30 k Rad (Si)
- Reference Voltage Set Internally to  $\pm 2\%$
- Built-In Thermal Overload Protection
- Short Circuit Current Limiting
- Product Is Available Screened To Class B and Class S, MIL-STD-883

## DESCRIPTION

These three terminal negative regulators are supplied in high density hermetically sealed packages and available Hi-Rel Screened. All protective features are designed into the circuit, including thermal shutdown, current limiting and safe-area control. With heat sinking, they can deliver over 3.0 amps of output current. These units feature 2% initial voltage tolerance, with 1.0% load regulation and .015% line regulation. These devices are ideally suited for Space applications where small size, high reliability, and radiation tolerance is required. The high level of Radiation Tolerance of these devices makes them a desirable choice for LEO and many MEO and GEO communication satellites. Radiation testing is performed on a single wafer by wafer basis. Random die samples per wafer are selected, packaged and radiation tested to qualify each individual semiconductor wafer-by-wafer.

## ABSOLUTE MAXIMUM RATINGS @ 25°C

Input Voltage .....	-35V
Operating Junction Temperature Range .....	-55°C to +150°C
Storage Temperature Range .....	-65° to +150°C
Thermal Resistance, Junction to Case	
TO-257 (Isolated), D <sup>2</sup> Pac (Isolated) .....	4.2°C/W
SMD-1 .....	3.5°C/W
Power Dissipation: TO-257/SMD/D <sup>2</sup> Pac .....	20W



**OMR1033SR, OMR1033ST, OMR1033NM**  
**OMNIREL'S RADIATION TEST PROCEDURE**

**Note:** Sample die from each wafer were tested at each kRAD increment shown above.

- Radiation Testing is performed on a single wafer by wafer basis.
- Each wafer is identified and a random sample of 5 die per wafer is selected.
- The die are then individually assembled in a hermetic package, data logged, electrically tested, hi-rel screened and then submitted to radiation testing.
- The packaged die are submitted to Steady State Total Dose radiation per Method 1019, Condition A at a dose rate of 50 RAD/sec biased at maximum supply voltage.
- Final electrical test is performed within two hours of Total Dose Radiation level from a Cobalt 60 source and 168 hr, 100°C annealing process. Read and record data including two non-radiated control samples.
- The wafer is then qualified only if samples from wafers meet full electrical specifications after 150% of total dose rating as specified in each product data sheet.
- Omnirel's controlling specifications are as follows: For Voltage Regulators the controlling specification is MIL-PRF-38534/MIL-STD-883.

**AVAILABLE PRODUCT SCREENING**

<b>Standard Class Level Screening MIL-PRF-38535</b>				
<b>Screen</b>	<b>Level B*</b>		<b>Level S*</b>	
	<b>Test Method</b>	<b>Required</b>	<b>Test Method</b>	<b>Required</b>
Wafer Lot Acceptance	-----	-----	5007	100%
Non-destructive Bond Pull	-----	-----	-----	-----
Pre-Cap Visual Inspection	2010	100%	2010	100%
Temperature Cycle	1010	100%	1010	100%
Constant Acceleration	2001	100%	2001	100%
Visual Inspection	-----	100%	-----	100%
PIND Test	-----	-----	2020	100%
Serialization	-----	-----	-----	100%
Pre-Burn-In Electrical	Data Sheet	100%	Data Sheet	100%
Burn-In	1015/160 hrs.	100%	1015/240hrs.	100%
Interim Electrical	-----	-----	Data Sheet	100%
PDA Calculations	5% Functional	Lot	5% Functional	Lot
Final Electrical	Data Sheet	100%	Data Sheet	100%
Fine & Gross Seal	1014	100%	1014	100%
Radiographic	-----	-----	2012/Two Views	100%
**Conformance Inspection	GR A	100%	GR A	100%
Final Visual Inspection	2009	Sample	2009	Sample

\* For "B" Level Screening add "M" to part number, for "S" Level Screening add "S" to part number, see part number designator.

\*\*Additional conformance inspection testing, i.e. Group B, C, & D optional.



## TYPICAL PERFORMANCE CHARACTERISTICS

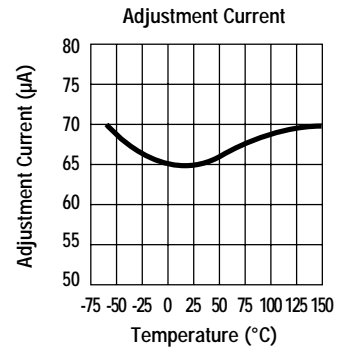
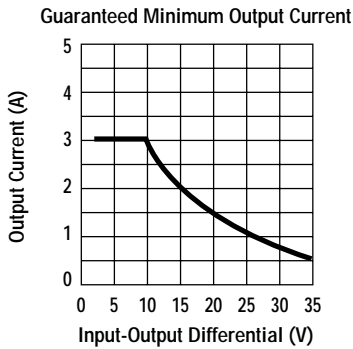
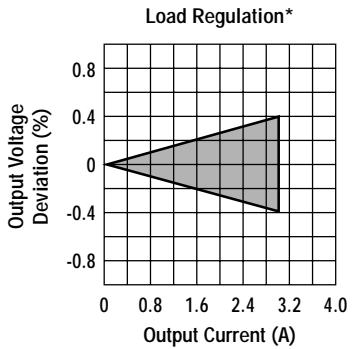
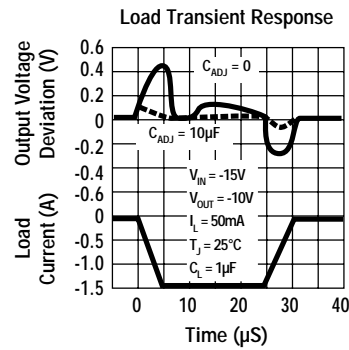
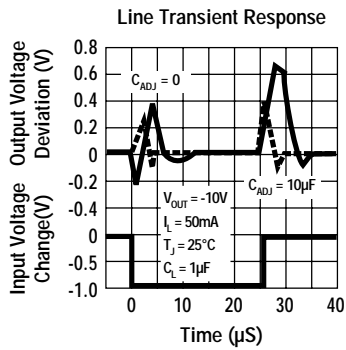
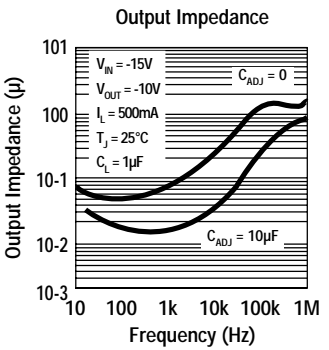
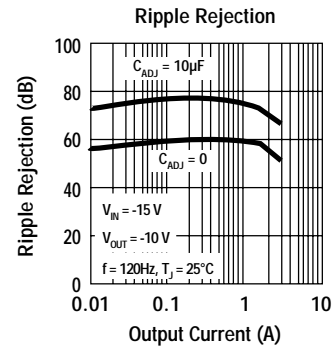
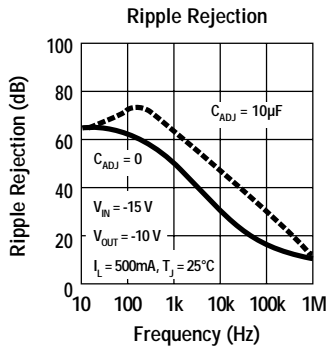
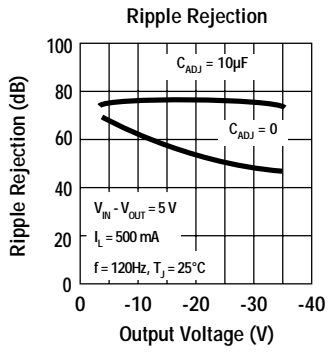
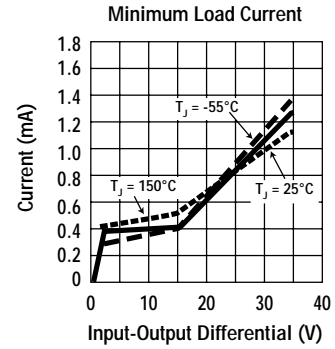
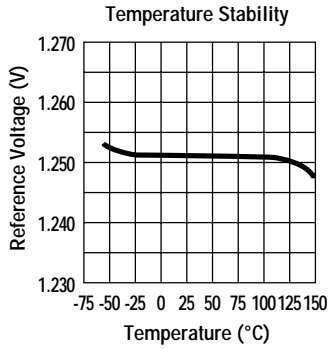
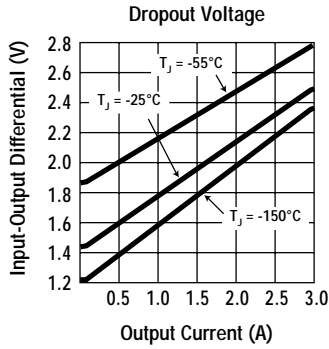

# OMR1033SR, OMR1033ST, OMR1033NM

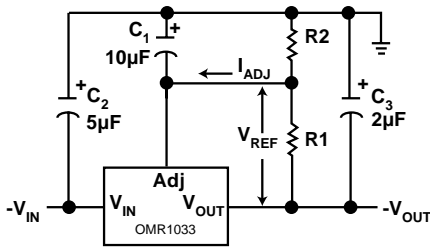
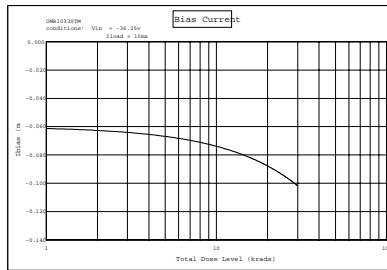
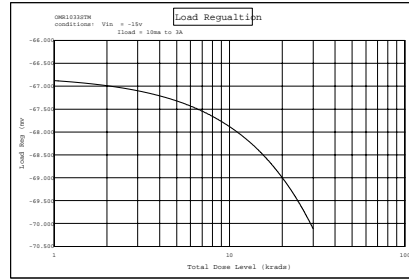
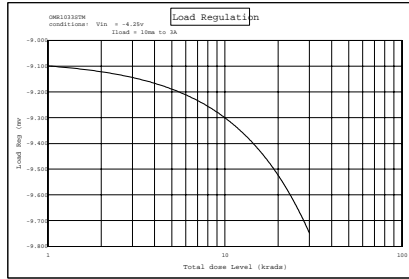
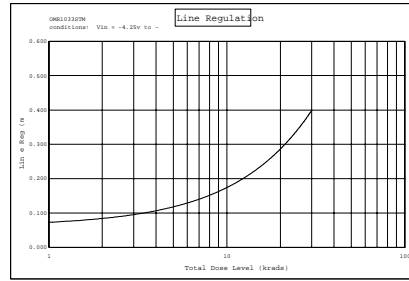
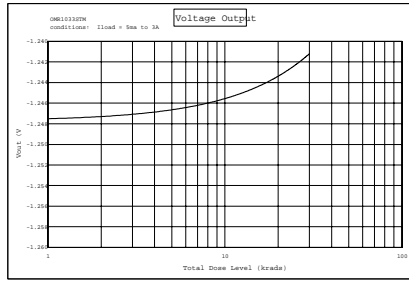

$$V_{OUT} = V_{REF} \left( 1 + \frac{R2}{R1} \right) + I_{ADJ} (R2)$$

## High Stability Regulator

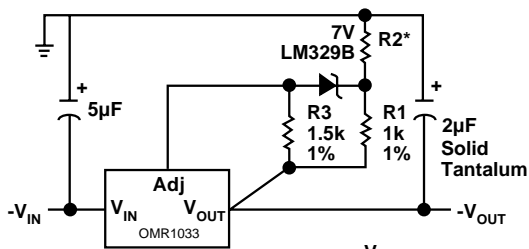

$$*R2 = \frac{V_{OUT}}{9.08 \times 10^{-3}} - 908\Omega$$

## Multiple Tracking Regulators

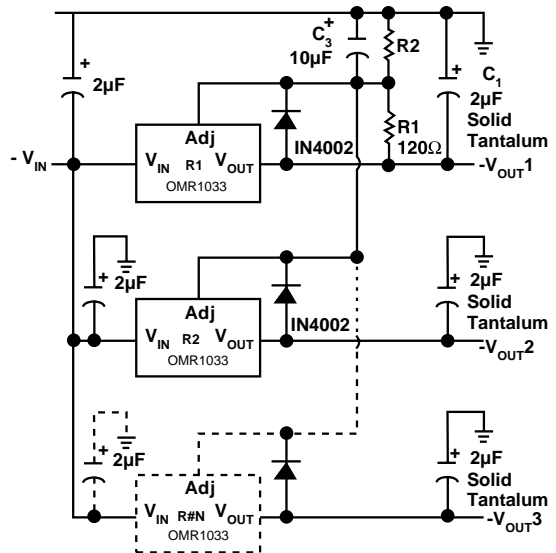

OMR1033SR, OMR1033ST, OMR1033NM

**MECHANICAL OUTLINES**

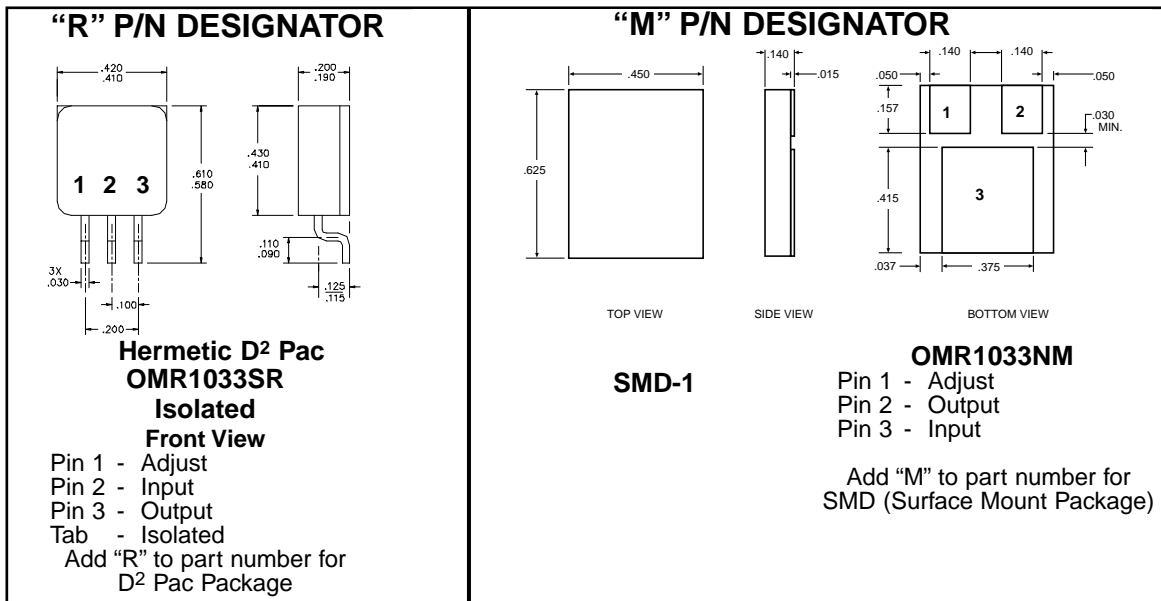
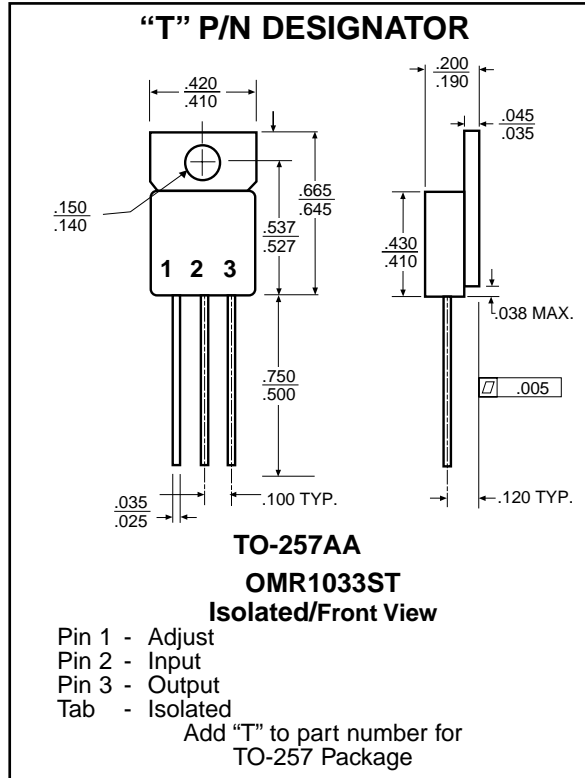

**PART NUMBER DESIGNATOR**  
(Example OMR1033STM)

