

Features

- 1/3 bias, 1/4 duty, 32x4 pattern, 3.0V LCD driver
- 14 kinds of built-in sound effects
- RC oscillator
- Auto power off function

General Description

HT113JA is a baseball LCD GAME designed by HOLTEK. Apart from the IC's own 14 types of special sound effects, the IC can work in con-

junction with the HT8121N voice IC to generate play calls like "STRIKE", "BALL", "OUT", "HOME RUN" and cheering.

LCD Pattern

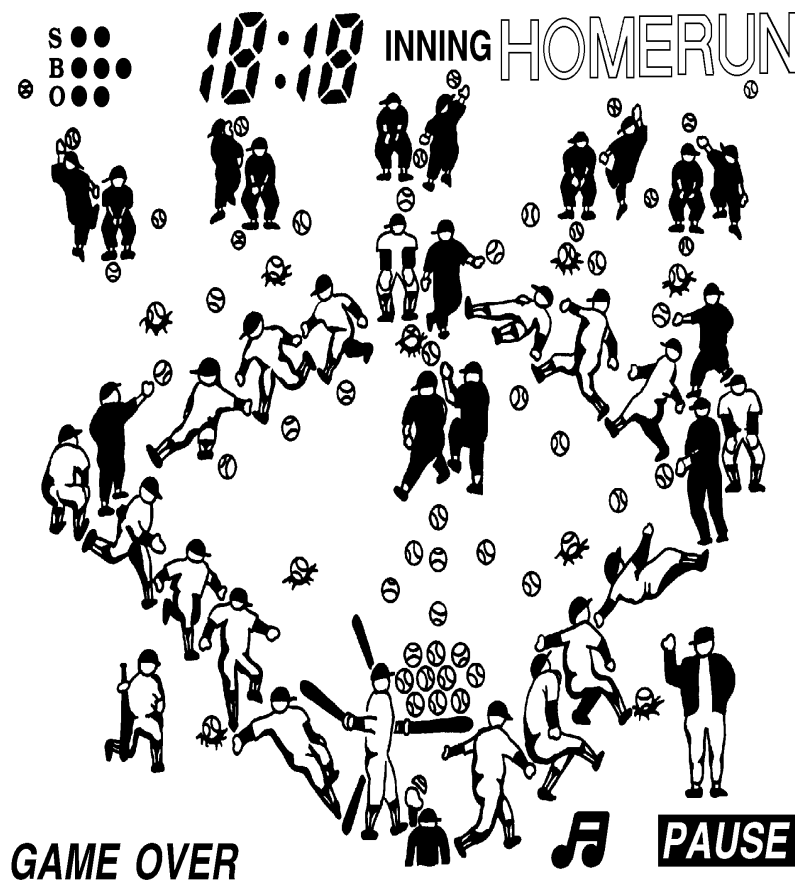

Functional Description

Key description

- **RESET**

Press this key and the whole system will restart from the beginning. The score and stage level are both cleared to zero. If the RESET key and the A key are both pressed at the same time, then the RESET key is released, all LCD pattern dots are shown on the screen for LCD testing.

- **START/PAUSE**

This key has two functions. The function START – above the slash – starts the game. After the system restarts, or the game is over or in free run mode, pressing this key starts a new game with a short musical accompaniment. Then, the game starts. When the game is in progress, pressing this key can temporarily stop the game. Pressing it again can resume the game.

- **MUTE**

This is a sound effect switch. Pressing it once can turn off the sound. Pressing it again switches it on.

- **A**

There are three functions to save:

- ♦ Pressing this key can set the LEVEL before the contest.
- ♦ Pressing this key can retrieve the ball.
- ♦ Pressing this key can pitch a ball.

- **B**

In defense, pressing the Left/Right key and this key can pitch a ball.

- **↑**

Direction key. In offense, pressing it can make the runner run from the first base to the second base. In defense, pressing it can pass the ball to the second base.

- **↓**

Direction key. In offense, pressing it can make the runner run from the third base to home base. In defense, pressing it can pass the ball to home base.

- **→**

Right direction key. When the player's pitcher is pitching, holding this key can make the ball veer to the right. Then, pressing A key or B key can either pitch an outside corner good ball or an outside corner bad ball. When the outfielder is passing the ball, pressing this key can pass the ball to the first base. Pressing this key can also shift the outfielder to the right to catch a flying ball.

- **←**

Left direction key. In offense, pressing this key can make the runner run to the third base. When the player's pitcher is pitching, holding this key can make the ball veer to the left. Pressing A key or B key can pitch an inside corner good ball or an inside corner bad ball. When the outfielder is passing the ball, pressing this key can pass the ball to the third base. Pressing this key can also shift the outfielder to the left to catch a flying ball.

- **ON/OFF**

Power switch. Press it once to turn on the power; press it once again to turn off the power; and so forth.

Operational description

- Press the ON/OFF key to turn on the power and the screen shows a pitch-catch practice. Press the A key to decide on the play level of the contest which is shown on the scoreboard. LEVEL 2 indicates higher hitting rate for the opponent's team during a game. Press the START key at any time to start the game. If no key is pressed within 15 seconds before the START key is pressed, it automatically goes into free-run mode. The system automatically operates the game. Press the A key at any time to select the required LEVEL or the START key to start the game. If no key is pressed within 4.5 minutes, the power is automatically turned off. If it is preferred to remain in free-run mode, press any key before auto power off so the time is recalculated.

- Press the START key and the game starts. The "1" innings on the screen flashes to show that it is in the first innings. START music is played. When the music is finished, the game starts and the scoreboard shows 0:0. The player is first to bat and by pressing the A key can take practice swings. From that point on, the opponent's pitcher is pitching and the catcher is catching, only one swing of the bat is allowed. If the ball is not struck, it is counted as strike. The decision whether strike or ball follows the regular rules of modern baseball. "S", "B", "O" on the upper left corner of the screen represents "Strike", "Ball" and "Out". Whenever a strike is made, a dot is added after the "S" mark to record a strike. At the same time, sound effects generate a "strike" call, and an "OUT" call. When there are 3 strikes, the player is out and "O" records one out on the upper left of the screen. Whenever a ball is pitched, a dot is added after the "B" mark to record a ball. At the same time, "ball" call is generated. When one player is out, a special sound is played. When three players are out, this inning is over. The inning number on the scoreboard flashes on the screen for several seconds and then it goes into the next round of play.
- When the ball is hit or there are four bad strikes the batter runs to the first base, the player automatically runs to the base. But it can be controlled only once. If the player is at offense and orders the runner to run continuously, press the direction key to shift it to the next base (refer to the Key Description). During the running, the runner cannot run backward.
- Foul ball is counted as a strike and a sound effect is played. If there are already two strikes, it is not taken into account.
- When the batting side hits a ball along the ground, the opposing side automatically catches that ball and throws it, when the player is defending, a ground ball is always caught. The player will hear a "Boo" sound to signify that the ball is in the fielder's glove. Then, press one of the direction keys to pass the ball to a base (refer to the Key Description). If the player does not pass, the opponent will decide if he/she should continue to run to the next base depending upon the distance of the ball from the batter.
- When the ball is hit into the air, it is accompanied by a sound effect appropriate to a high ball. If the opponent are fielding, and the last batter's ball is caught, any player that has begun a run or has reached the next base, is automatically returned to the base from which he ran. If the player's side is fielding, the player must press the Left/Right direction keys in order to move the fielder to a suitable position so that he/she can catch the high ball. If a fielder misses a catch, the fielder then runs to pick up the ball, after which a simulated crowd call will make a "Boo" sound to signify that the ball is in the fielder's mitt. Then, the ball can be passed to the most appropriate fielder (including the pitcher).
- When there is a HOME RUN, the game will generate a home run sound and a cheering sound. The runner runs back to home base while music is played. When the score is announced, music is played.
- When the runner is caught, the base from where ran flashes. The voice IC plays the "OUT" sound and the number of caught runners is recorded in the upper left hand corner of the screen.
- Whenever a runner either from the opponent or defense stops, a five second timer is started. During this 5-second interval, if the direction keys are not pressed the inning number on the scoreboard flashes on the screen for several seconds and then the system automatically operates the game.
- The second part of each inning the player plays defense. Press a direction key, A key and B key to control the pitching. There are five kinds of trajectory for the ball to follow:
 - ◆ Straight ball: Directly press A key or B key, but direction key is not pressed.
 - ◆ Inside corner strike: Press ← key and then press A key.
 - ◆ Outside corner strike: Press → key and then press A key.

- ◆ Inside corner ball: Press ← key and then press B key.
- ◆ Outside corner ball: Press → key and then press B key.
- If the player does not pitch within 7 seconds during his turn at defense, the pitcher will pitch a straight ball.
- If the score is even after the 9th inning, the match can be extended to a maximum of 19 innings.
- There are various ways to finish a game:
 - ◆ When the first part of the 7th inning is over, or the second part of the 7th and 8th inning is proceeding and the player's score is less than the opponent's by 10 or more points.
 - ◆ The second part of the 7th or 8th inning is over and the player's score is higher than the opponent's by 10 or more points.
 - ◆ The first part of the 9th inning is over or the second part of the 9th inning is proceeding, and the player's score is less than that of the opponent's.
 - ◆ The second part of the 9th inning or above is over and the player's score is higher than that of the opponent's.
 - ◆ When the score reaches 19.
 - ◆ The second part of the 19th inning is over.
- When the game is over, the screen reverts to the very beginning prior to the start. "GAME OVER" flashes on the bottom left corner. The result is shown on the scoreboard. At this point, the player can restart the game.
- Auto power off function: HT113JA has an auto power off function. It has a countdown time of 4.5 minutes. If no key is pressed within 4.5 minutes, power is automatically turned off to save energy. When power is off, press the ON/OFF key to turn it on. If any key is pressed before auto power off, the countdown is restarted.
- Pause function
 - ◆ During the game, press the PAUSE key at any time to stop the game. At this moment, the screen is frozen. Only "PAUSE" and the umpires are flashing relatively. Press the PAUSE key again, then the game continues.
- ◆ If the power has been switched off in the PAUSE mode (automatically or manually), the system will automatically save the screen. When power is turned on again, it will go back to the frozen screen. Press the PAUSE key again and the game continues.
- Displaying the scoreboard
 - The level, inning, or score will be shown on the scoreboard at the proper time according to the following:
 - ◆ LEVEL
 - Press Key A before the START key is pressed. It will show LEVEL 1 or LEVEL 2 (if not set, LEVEL 1 is assigned). The display looks like L:1 or L:2.
 - ◆ INNING
 - Conditions wherein the innings flashes are as follows:
 - After pressing the START key
 - Changing defense/offense position
 - During the game time, runner stops running and the defender stops passing the ball for 5 seconds.
 - ◆ SCORE
 - This is the player's score, the right one is the opponent's score. The highest score ratio is 19:19. It is shown in the following situation:
 - 0:0 is shown in pitching practice.
 - Score is shown after flashing inning.
 - When the game is over, score is shown.

Counting method

Counting method is in accordance with regular baseball rules.

Sound effects

- HT113JA consists of 14 kinds of sound effects.
 - ◆ Sound for hitting the ball
 - ◆ Sound for high ball
 - ◆ Sound for STRIKE
 - ◆ Sound for BALL

- ◆ Sound for moving the ball
- ◆ Music for changing defense/offense position
- ◆ Sound for HOME RUN
- ◆ Sound for ball being placed in a fielder's mitt
- ◆ Sound for winning points
- ◆ Sound for "OUT"
- ◆ Sound for a foul ball
- ◆ START music
- ◆ Music for pitching practice
- ◆ Running base music in HOME RUN
- Operating with HT8121N to produce these four sounds
 - ◆ STRIKE
 - ◆ BALL
 - ◆ OUT
 - ◆ HOME RUN and Cheering sound

LCD Display Label

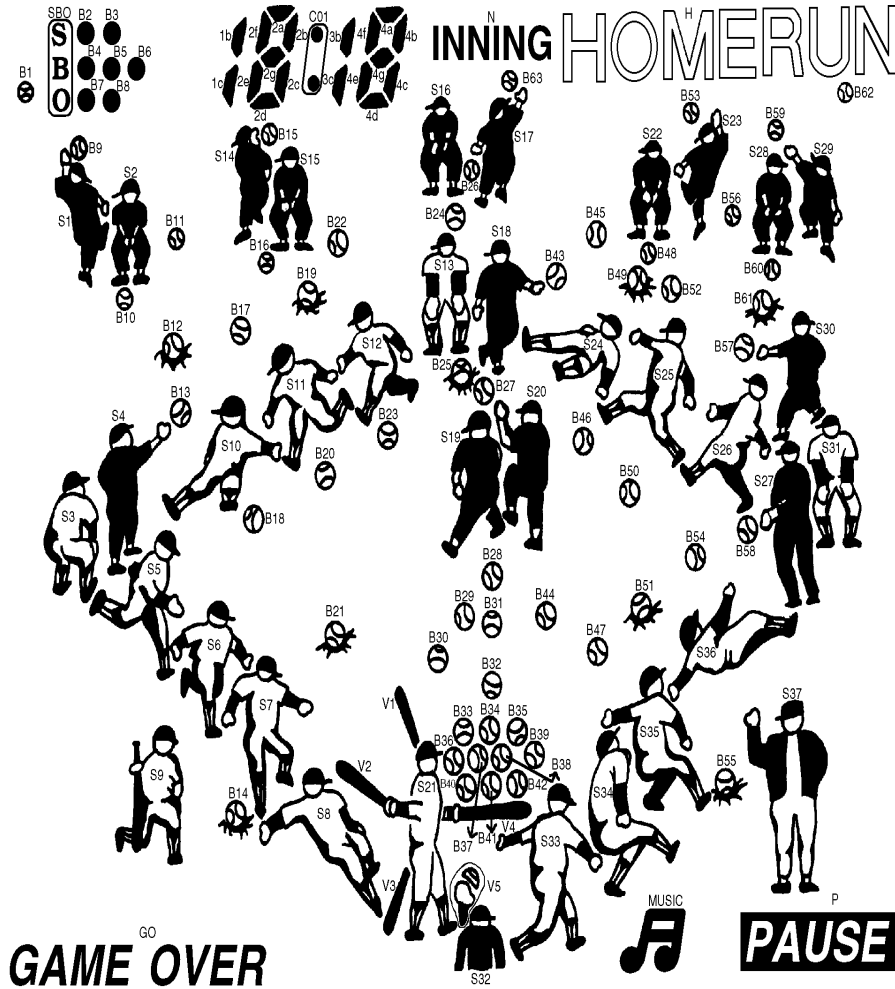

LCD Pattern Contrast Table

Pad No.	Pin No.	COM0	COM1	COM2	COM3	SEGMENT
5	36	—	—	—	COM3	COM3
6	35	—	—	COM2	—	COM2
7	34	—	COM1	—	—	COM1
8	33	COM0	—	—	—	COM0
34	32	CO1	B15	B19	B22	SEG0
35	31	3bc	4f	4d	4e	SEG1
36	30	4a	4b	4c	4g	SEG2
37	29	N	S16	S13	B24	SEG3
38	28	B63	S17	S18	B26	SEG4
39	27	H	B53	B43	B45	SEG5
40	26	S23	S22	B49	B48	SEG6
41	25	S29	S28	B61	B60	SEG7
42	24	B62	B59	B57	B56	SEG8
43	23	P	S31	S30	S27	SEG9
44	22	M	S37	S26	B58	SEG10
45	21	B55	S36	B52	B54	SEG11
46	20	S35	B51	S25	B50	SEG12
47	19	S34	B47	S24	B46	SEG13
48	18	S33	B44	B28	B31	SEG14
49	17	B42	B39	B29	B35	SEG15
50	16	S32	B41	B32	B38	SEG16
51	15	V4	B40	B34	B37	SEG17
52	14	V5	B36	B30	B33	SEG18
53	13	S21	V1	B27	S20	SEG19
54	12	V3	V2	B25	S19	SEG20
55	11	S8	B21	S12	B23	SEG21
56	10	B14	S7	B20	S6	SEG22
57	9	GO	S5	B13	S4	SEG23
58	8	S9	S3	B10	B12	SEG24
59	7	B1	SBO	S1	B9	SEG25
60	6	B2	B4	S2	B7	SEG26
61	5	B3	B5	B11	B8	SEG27
62	4	B6	B17	B18	S10	SEG28
63	3	S14	S15	S11	B16	SEG29
64	2	1bc	2f	2d	2e	SEG30
65	1	2a	2b	2c	2g	SEG31

LCD Package Outline

Unit : mm

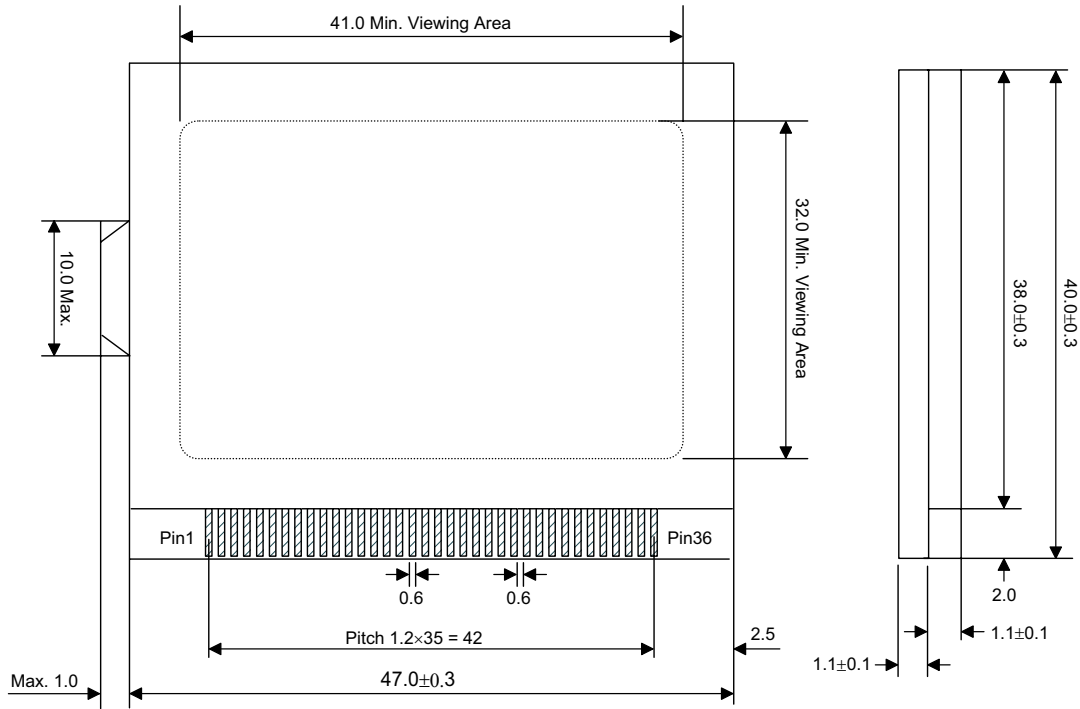

Specifications

Top polarizer: Transmissive (46.00mm×39.00mm)

Bottom polarizer: Transmissive (46.00mm×37.00mm)

Storage temperature: -20°C to 70°C

Operating temperature: -10°C to 60°C

Viewing angle: 6 o'clock

Drive condition: 3V, 1/4 duty, 1/3 bias

Display mode: Tn, normal type

Pad Assignment

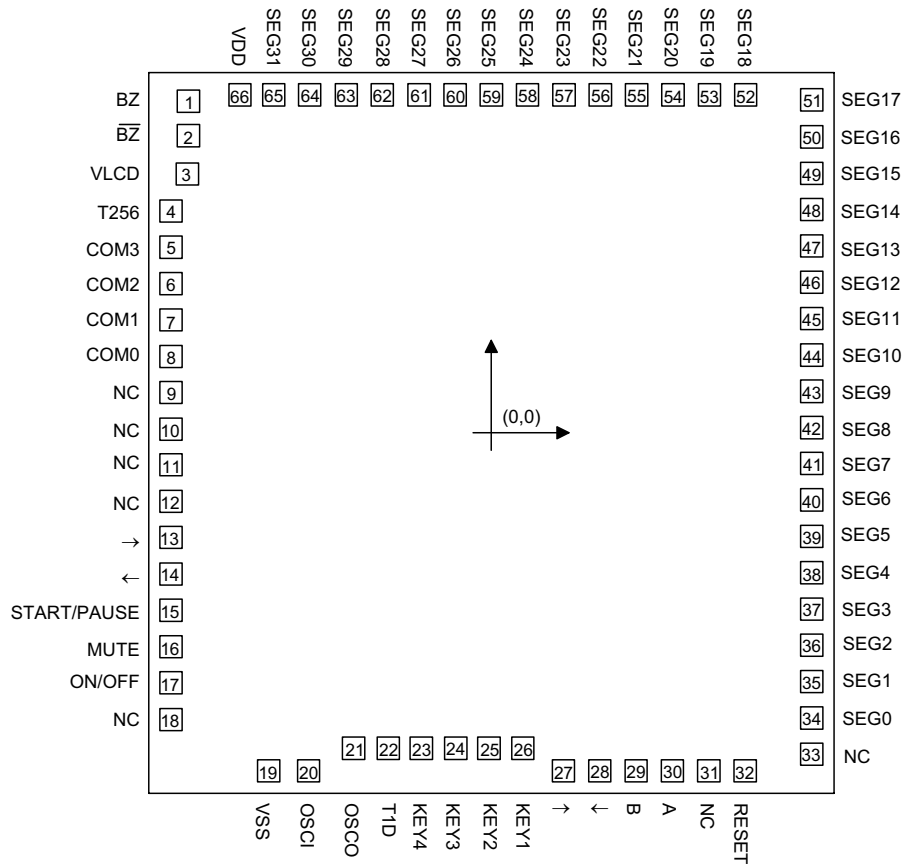

Chip size: 2780×2990 (μm)²

* The IC substrate should be connected to VSS in the PCB layout artwork.

Pad Coordinates

 Unit: μm

Pad No.	X	Y	Pad No.	X	Y
1	-1192.10	1305.20	34	1261.10	-1122.30
2	-1192.10	1169.80	35	1261.10	-979.80
3	-1196.70	1019.80	36	1261.10	-836.30
4	-1261.10	873.70	37	1261.10	-693.80
5	-1261.10	731.20	38	1261.10	-550.30
6	-1261.10	587.70	39	1261.10	-407.80
7	-1261.10	445.20	40	1261.10	-264.30
8	-1261.10	301.70	41	1261.10	-121.80
9	-1261.10	159.20	42	1261.10	21.70
10	-1261.10	15.70	43	1261.10	164.20
11	-1261.10	-126.80	44	1261.10	307.70
12	-1261.10	-270.30	45	1261.10	450.20
13	-1261.10	-412.80	46	1261.10	593.70
14	-1261.10	-556.30	47	1261.10	736.20
15	-1261.10	-698.80	48	1261.10	879.70
16	-1261.10	-842.30	49	1261.10	1022.20
17	-1261.10	-984.80	50	1261.10	1165.70
18	-1261.10	-1128.30	51	1261.10	1311.20
19	-876.70	-1331.40	52	1001.00	1331.40
20	-719.70	-1331.40	53	858.50	1331.40
21	-542.10	-1241.00	54	715.00	1331.40
22	-406.70	-1241.00	55	572.50	1331.40
23	-276.30	-1241.00	56	429.00	1331.40
24	-140.90	-1241.00	57	286.50	1331.40
25	-10.50	-1241.00	58	143.00	1331.40
26	124.90	-1241.00	59	0.50	1331.40
27	284.90	-1331.40	60	-143.00	1331.40
28	427.40	-1331.40	61	-285.50	1331.40
29	570.90	-1331.40	62	-429.00	1331.40
30	713.40	-1331.40	63	-571.50	1331.40
31	856.90	-1331.40	64	-715.00	1331.40
32	999.40	-1331.40	65	-857.50	1331.40
33	1261.10	-1265.80	66	-990.50	1331.40

Absolute Maximum Ratings

Supply Voltage-0.3V to 5.5V Storage Temperature.....-50°C to 125°C
 Input Voltage $V_{SS}-0.3V$ to $V_{DD}+0.3V$ Operating Temperature0°C to 70°C

Note: These are stress ratings only. Stresses exceeding the range specified under Absolute Maximum Ratings may cause substantial damage to the device. Functional operation of this device at other conditions beyond those listed in the specification is not implied and prolonged exposure to extreme conditions may affect device reliability.

Electrical Characteristics
 $T_a=25^\circ\text{C}$

Symbol	Parameter	Test Conditions		Min.	Typ.	Max.	Unit
		V_{DD}	Conditions				
V_{DD}	Operating Voltage	—	—	2.4	3	3.3	V
I_{DD}	Operating Current	3V	No load, $f_{SYS}=512\text{kHz}$	—	300	500	μA
I_{STB}	Standby Current	3V	System halt	—	1	5	μA
V_{LCD}	LCD Supply Voltage	3V	—	—	3	—	V
f_{SYS}	Operating Frequency	3V	$R=36\text{k}\Omega$	—	512	—	kHz

Application Circuits

Speaker application with voice

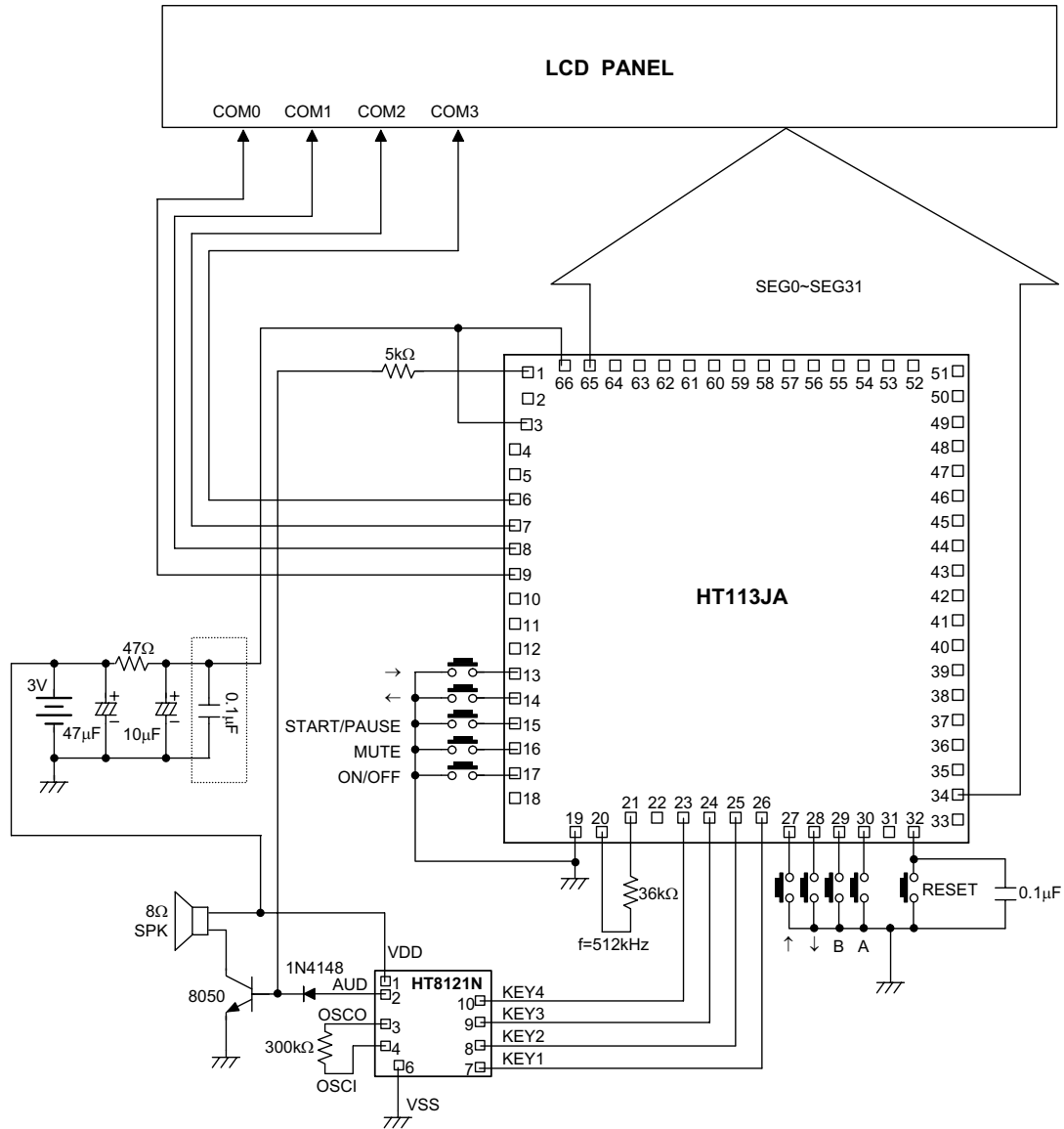

Note: The capacitor in dash block is recommended.
 The IC substrate should be connected to VSS in the PCB layout artwork.

Speaker application without voice

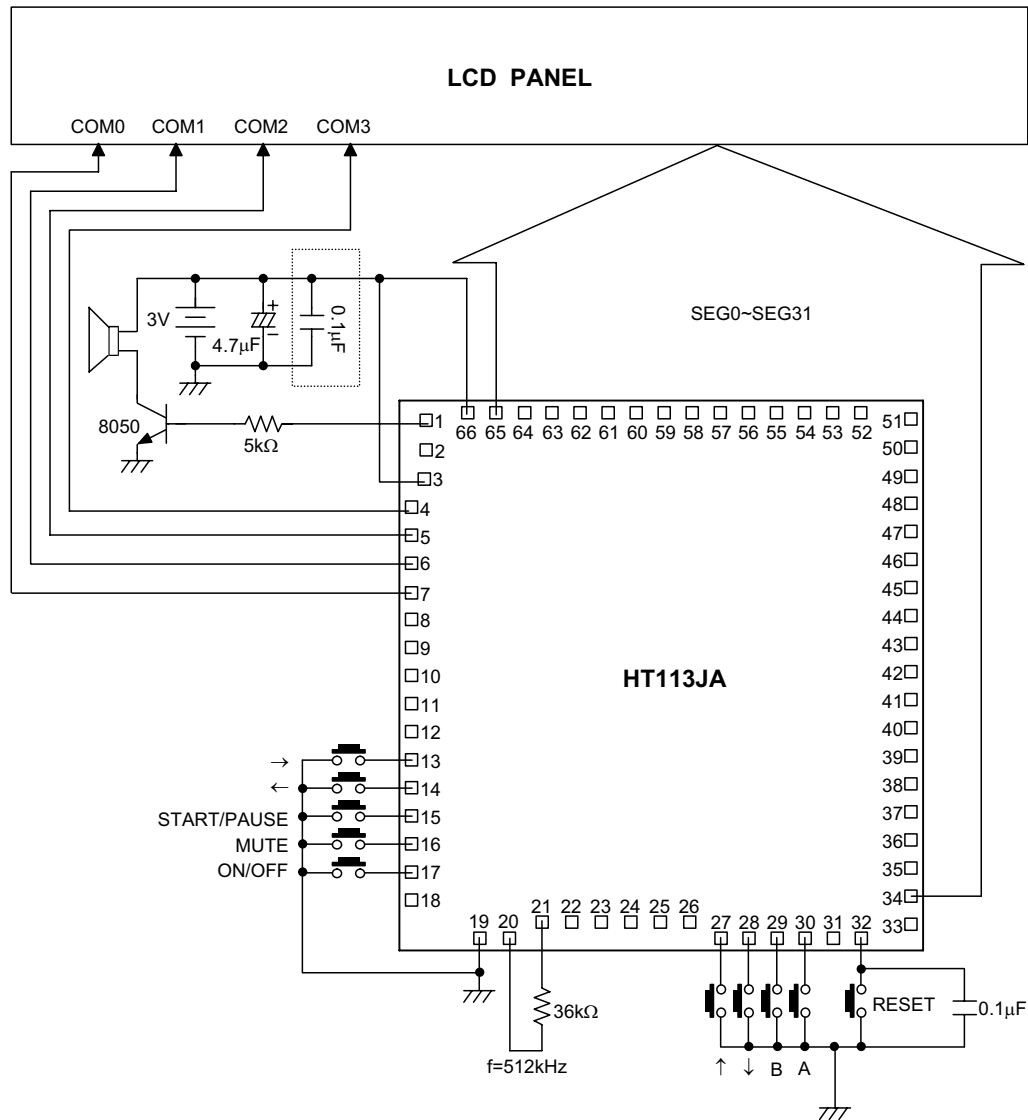

Note: The capacitor in dash block is recommended.
 The IC substrate should be connected to VSS in the PCB layout artwork.

Buzzer application without voice

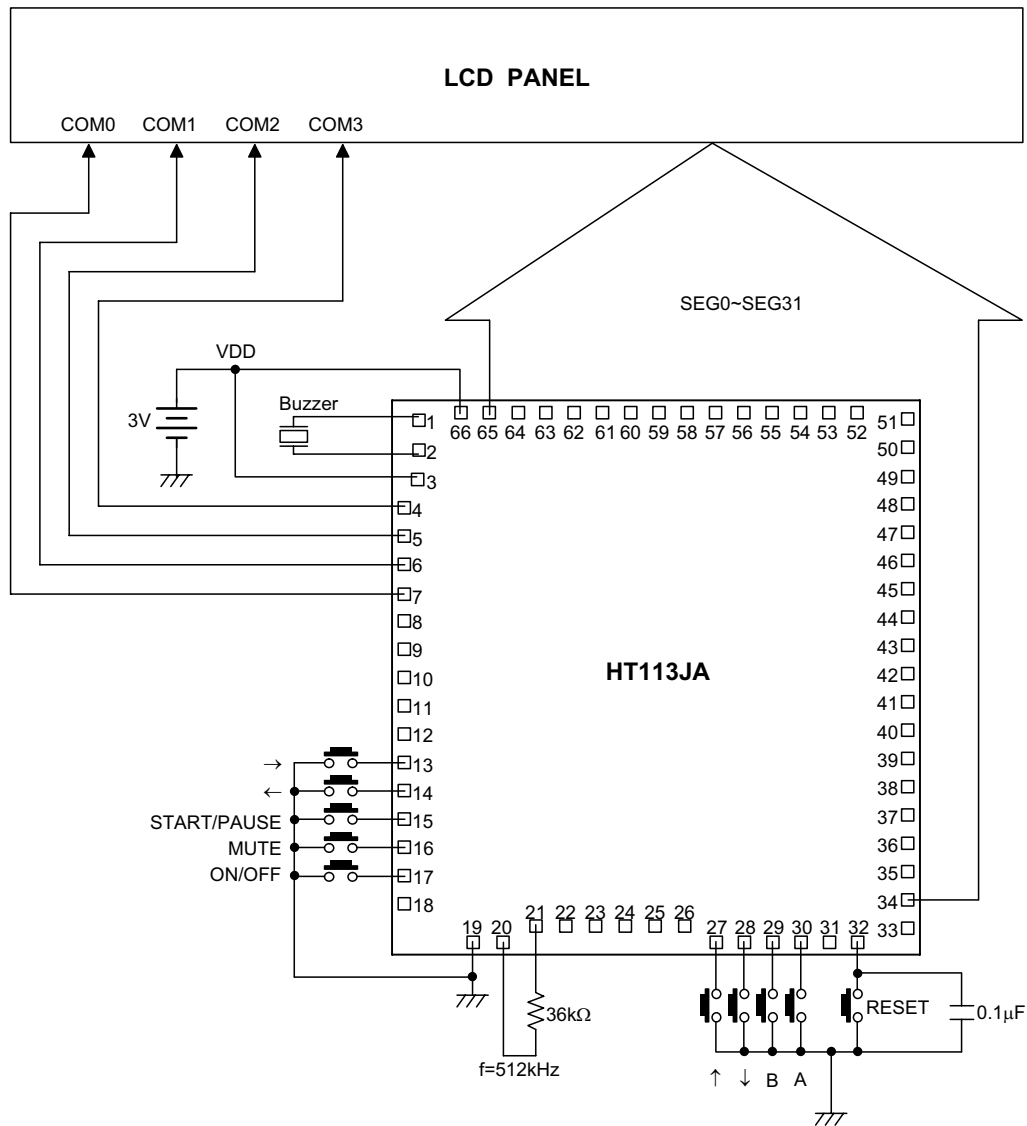

Note: The IC substrate should be connected to VSS in the PCB layout artwork.

Holtek Semiconductor Inc. (Headquarters)

No.3 Creation Rd. II, Science-based Industrial Park, Hsinchu, Taiwan, R.O.C.
Tel: 886-3-563-1999
Fax: 886-3-563-1189

Holtek Semiconductor Inc. (Taipei Office)

5F, No.576, Sec.7 Chung Hsiao E. Rd., Taipei, Taiwan, R.O.C.
Tel: 886-2-2782-9635
Fax: 886-2-2782-9636
Fax: 886-2-2782-7128 (International sales hotline)

Holtek Semiconductor (Hong Kong) Ltd.

RM.711, Tower 2, Cheung Sha Wan Plaza, 833 Cheung Sha Wan Rd., Kowloon, Hong Kong
Tel: 852-2-745-8288
Fax: 852-2-742-8657

Copyright © 1999 by HOLTEK SEMICONDUCTOR INC.

The information appearing in this Data Sheet is believed to be accurate at the time of publication. However, Holtek assumes no responsibility arising from the use of the specifications described. The applications mentioned herein are used solely for the purpose of illustration and Holtek makes no warranty or representation that such applications will be suitable without further modification, nor recommends the use of its products for application that may present a risk to human life due to malfunction or otherwise. Holtek reserves the right to alter its products without prior notification. For the most up-to-date information, please visit our web site at <http://www.holtek.com.tw>.